

DM-S500

SERVICE MANUAL

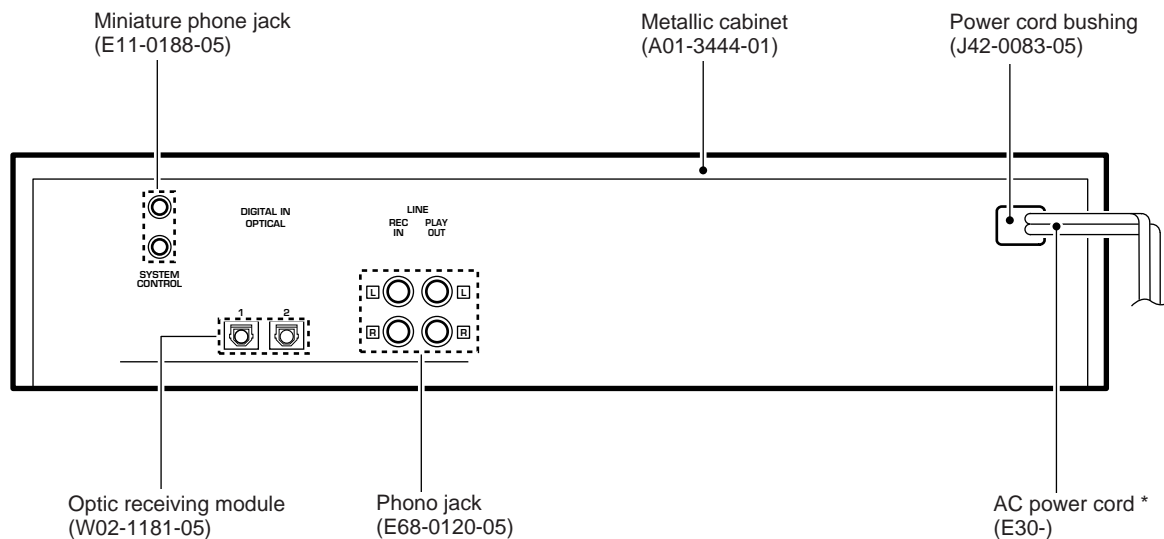
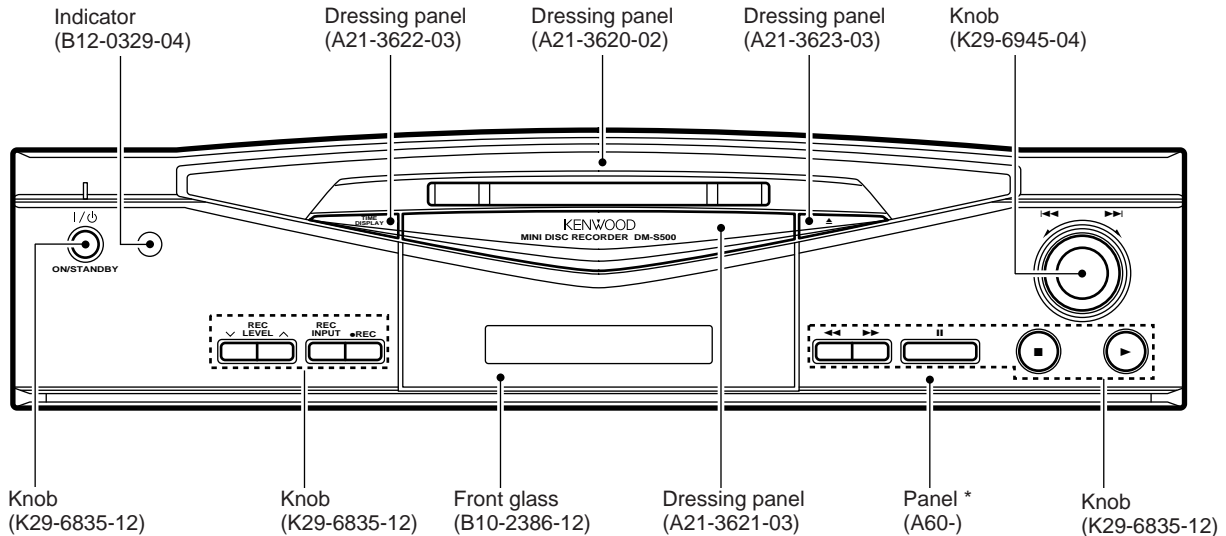

* Refer to parts list on page 25.

In compliance with Federal Regulations, following are reproductions of labels on, or inside the product relating to laser product safety.

KENWOOD-Crop. certifies this equipment conforms to DHHS Regulations No. 21 DFR 1040. 10, Chapter 1, Subchapter J.

**DANGER : Laser radiation when open and interlock defeated.
AVOID DIRECT EXPOSURE TO BEAM**

Refer to DM-SE7/SE9 (B51-5395-00) and DM-5090/9090 (B51-5387-00) service manuals if require circuit description.



DM-S500

CONTENTS / ACCESSORIES / CAUTIONS

Contents

CONTENTS / ACCESSORIES / CAUTIONS	2	SCHEMATIC DIAGRAM	13
CONTROLS	3	EXPLODED VIEW	23
ADJUSTMENT	5	PARTS LIST	25
PC BOARD	10	SPECIFICATIONS	Back cover

Accessories

Audio cord (2)
(E30-0505-05)

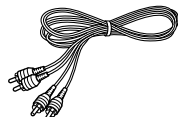

System control cord (1)
(E30-2733-05)

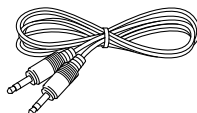

Optical fiber cable (1)
(B19-1529-05)



Remote control unit (1)
(A70-1187-05)

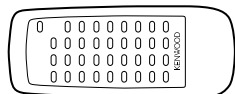

Batteries (2)

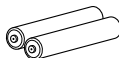

AC plug adaptor (1)
(E03-0115-05)

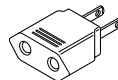

Use to adapt the plug on the power cord to the shape of the wall outlet. (Accessory only for regions where use is necessary.)

Battery cover (A09-0356-08)

Cautions

Note related to transportation and movement

Before transporting or moving this unit, carry out the following operations.

1. With no disc loaded in the unit, press the ON/STANDBY key to on.
 - Check that no disc is present in the unit.
2. Wait a few seconds and verify that the display shown appears.
3. Press the ON/STANDBY key to off (standby).



NO DISC

Maintenance

Cleaning

Unplug this appliance from the wall outlet before cleaning. Do not use volatile solvents such as alcohol, paint thinner, gasoline, or benzene, etc. to clean the cabinet. Use a clean dry cloth.

Caution against contact revitalizer

Do not use contact cleaners because it could cause a malfunction. Be specially careful against contact cleaners containing oil, for they may deform the plastic components.

CONTROLS

Display / Main unit

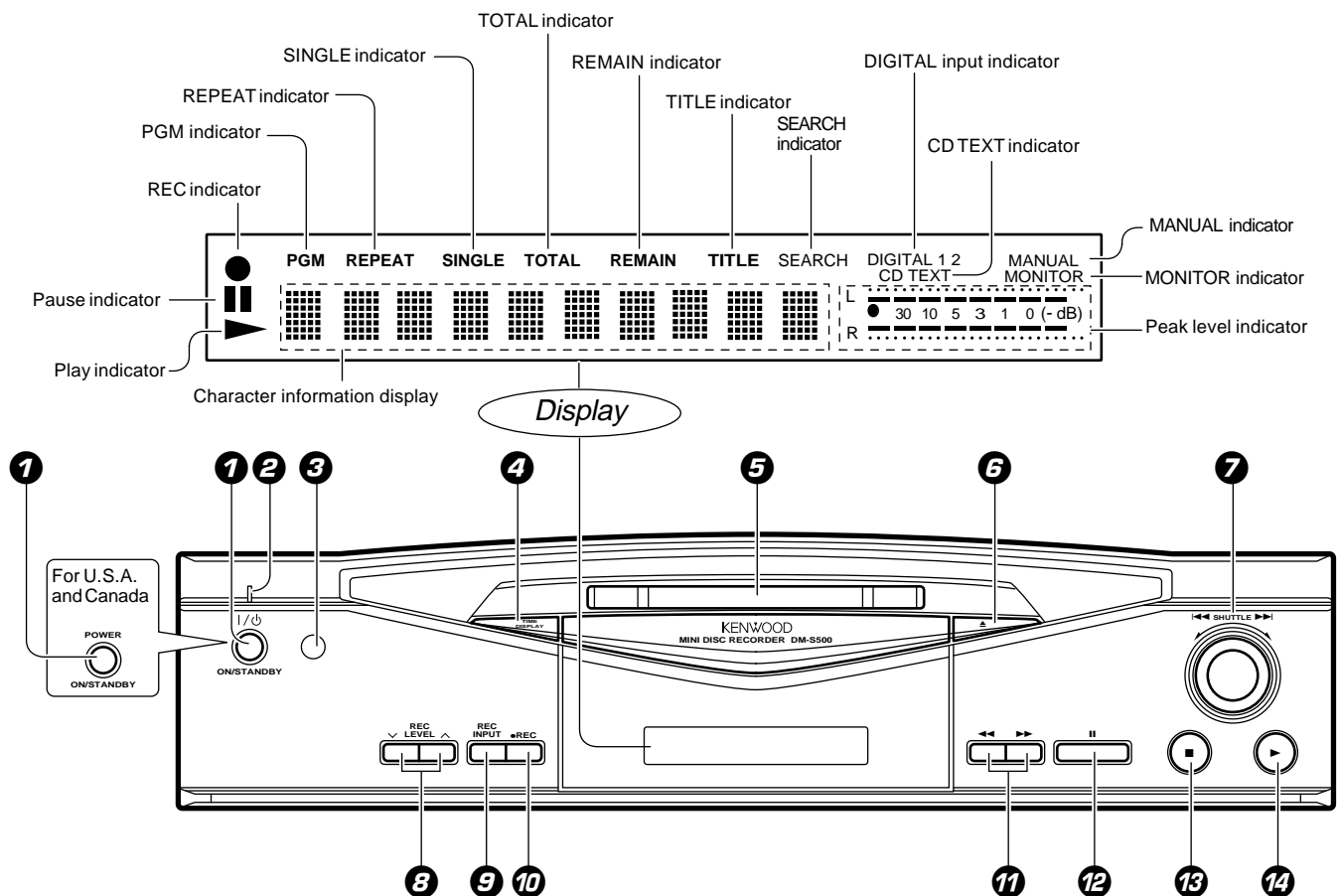

1 ON/STANDBY (I / ⏻) key

Press to turn the unit on or off (standby).

1 POWER key (For U.S.A. and Canada)

Press to turn the unit on or off.

2 Standby indicator

3 Remote control sensor

The key control signals from the remote control unit enter the main unit from here.

4 TIME DISPLAY key

5 Mini Disc insertion slot

Insert a minidisc.

6 Eject (▲) key

Press to unload the Mini Disc.

7 SHUTTLE (◀◀, ▶▶) knob

Use to skip disc tracks during playback.

During editing, this knob is used to select track numbers, title and characters.

8 REC LEVEL keys

This key is used to adjust the recording level.

9 REC INPUT key

This key is used to switch the recording input source.

10 REC (●) key

Press when starting recording.

11 Fast forward and fast backward (◀◀, ▶▶)

During playback, this key is used to move the played position forward or backward.

At the time of editing, the cursor movement and the selected title can be confirmed.

12 Pause (II) key

Press to temporary stop the disc operation.

13 Stop (■) key

Press to stop the disc operation.

14 Play (▶) key

Press to start playback.

About the **STANDBY** mode

While the STANDBY indicator is lit on the display, a small amount of power is supplied to the system to back up the memory. This is called the standby mode. Under that condition, the system can be turned ON by the remote control unit.

Remote control unit

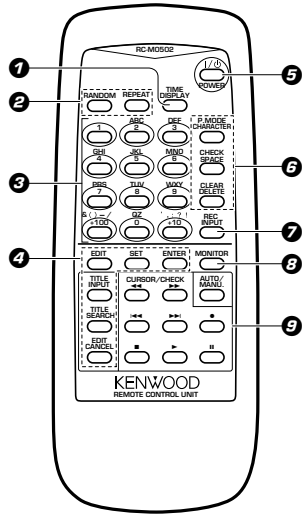

Model: RC-M0502
Infrared ray system

- 1 TIME DISPLAY key**
: Press to switch the time display mode.
- 2 Applied operation keys**
RANDOM key
: Used at the time of random playback.
REPEAT key
: Press to play tracks repeatedly.
- 3 Numeric keys**
: Press to specify the desired track number.
: Used at the time of title input for selection of characters and symbols.
- 4 Edit operation keys**
EDIT key
: This key is used to switch the editing mode.
SET key
: Press to set the editing result or input title definitely in memory.
ENTER key
: Press to execute editing or title input operation.
TITLE INPUT key
: This key is used to switch the title input mode.
TITLE SEARCH key
: This key is used to switch the title search mode.
EDIT CANCEL key
: Used to cancel editing.
- 5 POWER (I/⏻) key**
: Press to turn the unit on or off (standby).
- 6 Program operation keys**
P.MODE (Play mode)/CHARACTER key
: This key is used in program playback. During title input, it is used to select the character group.
CHECK/SPACE key
: This key is used to check the program contents.
During title input, it is used to insert a blank space character.
CLEAR/DELETE key
: This key is used to clear the program. During title input, it is used to delete a character.
- 7 REC INPUT (Recording input) key**
: This key is used to switch the recording input source.
- 8 MONITOR key**
: The sound of the unit connected to "DIGITAL 2" is heard.
- 9 Basic operation keys**
Fast Forward and Fast Backward keys
: Fast forward and fast backward keys.
(Same function as the keys on the main unit.)
Skip keys
: Skip keys.
(Same function as the knob on the main unit.)
● : Record key ■ : Pause key
▶ : Stop key ► : Play key
- AUTO/MANU. key**
: This is used for selection of automatic (AUTO) or manual (MANU.) track number assignment at the time of recording.

Graphical Remote Control Unit (GRC)

A graphical remote control (GRC-151, GRC-102 or GRC-101) is sold separately. To enable remote control operation, simply connect this unit, cassette deck (sold separately), and other accessories to the AV CONTROL CENTER with the system control cords.

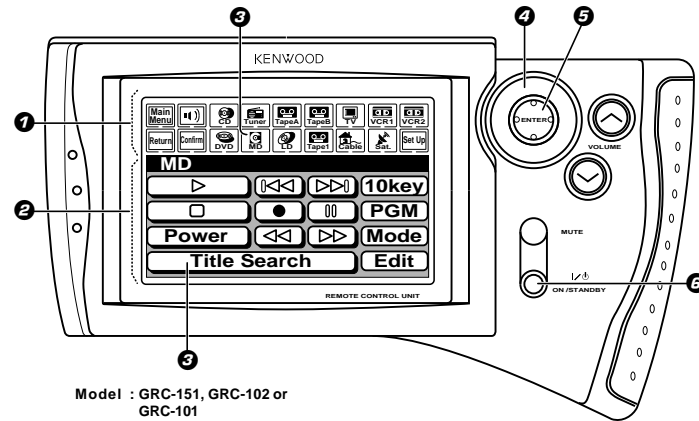

Model : GRC-151, GRC-102 or
GRC-101
Infrared ray system

1 Segment screen
This screen is used for selecting the icons for the main equipment.

2 Menu screen
This screen is used for selecting the icons for the operating modes.

MD recorder operation panel

Play icon (▶)

Pause icon (||)

Stop icon (■)

Search icons (◀◀ ▶▶)

These icons send the track forward or backward.

Mode icon

This icon is used to select the playback mode.

Skip icons (◀◀ ▶▶)

When selected, the next track in the icon direction is played.

10key Pad icon

This icon switches to the Numeric Icon menu screen.

Power icon

This icon is used to turn the unit on or off. You can use this icon only when you select "IR" in the setup menu.

Rec icon (●)

This icon is used for recording.

PGM icon

This icon is used for program playback.

Edit icon

This icon is used to select the editing mode.

Title Search icon

This icon is used to switch the title search mode.

3 Icons
Icons for the equipment used and operating mode are displayed.

4 Joystick
The joystick is used when selecting the icons.
(Lightly press the edge of 4.)

5 ENTER key
Press this button to input the selected icon (operation mode, and so on).

6 I/⏻ (ON/STANDBY) key
This key turns ON/STANDBY this unit or the equipment connected with the system control cords.

If your GRC unit is the GRC-100 or GRC-150

If the GRC unit provided with your AV CONTROL CENTER (optional) or receiver (optional) is the "GRC-100" or "GRC-150", the DM-S500 unit should be controlled using the remote control unit provided with this unit.

ADJUSTMENT

1. Test mode of the unit

1-1 Setting of the test mode

While pressing the [STOP] key, plug the AC power cord into the AC wall outlet.

1-2 Contents of the test mode

- ① [DOT TEST]
- ② [SEG TEST]
- ⌘ ③ [KEY TEST]
- ⌘ ④ [CYBER TEST] J type only

⌘ Used for production line only

1-3 Function of the test mode

- ① [DOT TEST]

The FL display starts the "NIAGARA MODE" by pressing the [PLAY] key in the [DOT TEST] mode.

- ② [SEG TEST]

Turn the FL indication ON by pressing the [PLAY] key in the [SEG TEST] mode.

The FL indication changes cyclically as shown in the below by turning the SHUTTLE (←→→→←).

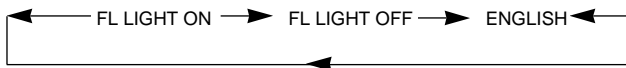

1-4 Function of the key

- ① SHUTTLE (→→→) and down (←←←) keys

: Selects the test mode.

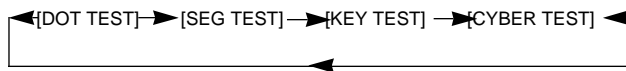

: Selects the FL indication



- ② Play key

: Proceeds the test mode or return to test mode.

- ③ Stop key

: Cancel the test mode.

1-5 Microprocessor reset

The microprocessor can be initialized while pressing the [EJECT] key, plug the AC power cord into the AC wall outlet.

2. Mechanism test mode

2-1 Setting the test mode

While pressing the [PLAY] key, plug the AC power cord into the AC wall outlet

2-2 Canceling the test mode

Unplug the AC power cord.

2-3 Basic operation in test mode

All operations are performed using the SHUTTLE (up/down), PLAY key and STOP key. The functions of each key are shown in the table below.

Function	Description
SHUTTLE (up/down)	Changes the parameter and mode.
PLAY key	Proceeds for definition.
STOP key	Returns for interrupt.

2-4 Selection of test mode

12 test modes are selected by turning the SHUTTLE.

No.	Display	Description	Section
1	TEMP ADJU	The work of adjustment is unnecessary in this mode	-
2	LDPWR ADJU	Laser power adjustment	3-5
3	LDPWR CHEC	Laser power check	3-5
4	EFBAL ADJU	Traverse adjustment	3-6
5	FBIAS ADJU	Focus bias adjustment	3-7
6	CPLAY MODE	Continuous playback mode	2-4-1
7	CREC MODE	Continuous recording mode	2-4-2
8	STT-LIMIT	Check the mechanism start limit SW position	-
9	JUMP MODE	Track jump checking mode	-
10	SRV DATA RE	Servo data reading	-
11	EEP MODE	E2PPROM data reading or rewrite	-
12	EEP INITIA	E2PROM data initializing	-

For more information on each adjustment mode, refer to each section of 3, "Electrical adjustment".

If other adjustment mode has been entered incorrectly, press the STOP key to exit the mode.

* The number 8 - 12 are not used for service. If these mode have been entered incorrectly, press the STOP key immediately to exit the mode. Specially, do not use EEP INITIAL. (E2PROM data has initialized if used it.)

2-4-1 Operation in continuous playback mode

1. Entering the continuous playback mode

- (1) Insert a recordable disc or pre-mastered disc into the unit.
- (2) Turn the SHUTTLE to display "CPLAY MODE".
- (3) Press the PLAY key. The display then changes from "CPLAY MODE" to "CPLAY MID".
- (4) After the access operation is completed, the display changes from "CPLAY MID" to "C=#### a=##".

Note: Numerals on the display appear the error rate and ADIP error.

2. Change the playback point.

- (1) Press the PLAY key during continuous playback. The display then changes as follows.

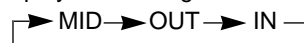

- (2) After the access operation is completed, the display changes "C=#### a=##".

DM-S500

ADJUSTMENT

Note: Numerals on the display appear the error rate and ADIP error.

3. Terminating the continuous playback mode

- (1) Press the STOP key. The display then changes to "CPLAY MODE".
- (2) Press the EJECT key to take out the disc.

Note : The playback start addresses of IN, MID, and OUT are described below.

IN	30H cluster
MID	300H cluster
OUT	700H cluster

2-4-2 Operation in continuous recording mode

1. Entering the continuous recording mode

- (1) Insert a recordable disc into the unit.
- (2) Turn the SHUTTLE to display "CREC MODE".
- (3) Press the PLAY key. The display then changes from "CREC MODE" to "CREC MID".
- (4) Press the PLAY key again. The display changes from "CREC MID" to "CREC (#####)", and the continuous recording is started.

Note : Numerals on the display (#####) appear the address of recording point.

2. Change the recording point.

- (1) Turn the SHUTTLE to clockwise while "CREC MID" is displayed. The display changes as follows. (The recording point can be shifted.)

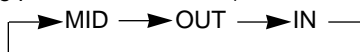

- (2) Press the ENTER key. The display then changes to "CREC(#####)", and the continuous recording is started.

Note : Numerals on the display (#####) appear the address of recording point.

3. Terminating the continuous recording mode

- (1) Press the STOP key. The display then changes to "CREC MODE" and the REC display goes off.
- (2) Press the EJECT key to take out the disc.

Notes :

1. The recording start addresses of IN, MID, and OUT are described below.

IN	30H cluster
MID	300H cluster
OUT	700H cluster

2. The STOP key can be pressed at any time to stop the recording.
3. An erasure prevention control is not detected in the test mode. Be careful not to enter the continuous recording mode using a disc containing the data that should not be erased.
4. Do not record continuously for more than five minutes.
5. Take care that no vibration is applied during continuous recording.

2-5 Other key function

Function	Description
▶	Plays back continuously when this key is pressed during stop. Turn on and off the tracking servo when it is pressed during continuous playback.
■	Stops the continuous playback and recording.
◀◀	The thread moves to the inner circumference while this key is pressed.
▶▶	The thread moves to the outer circumference while this key is pressed.

Note : An erasure prevention control is not detected in the test mode. Notice that recording is performed irrespective of the erasure prevention control position when the REC key is pressed.

2-6 Precaution on use of test mode

⚠ An erasure prevention control is not detected in the test mode. Therefore, when the recording laser power mode such as continuous recording mode and traverse adjustment mode is entered, the contents of the existing recording are erased irrespective of the control position. Be careful not to enter the continuous recording mode and traverse adjustment mode when using a disc, containing the data that should not be erased, in the test mode.

3. Electrical adjustment

3-1 Precaution during confirmation of Laser Diode emission

During adjustment, do not view the emission of a laser diode from just above for confirmation. This may damage your eyes.

3-2 Precaution on handling of Optical pick-up (KMS-260A)

The laser diode in an optical pick-up is easy to be subject to electrostatic destruction. Therefore, solder-bridge the laser tap on the flexible board when handling the optical pick-up. When removing the flexible board from the connector, make a solder bridge in advance, then remove the board. Be careful not to remove the solder bridge before inserting the connector. Moreover, take careful measures against electrostatic destruction. The flexible board is cut easily. Handle the flexible board with care.

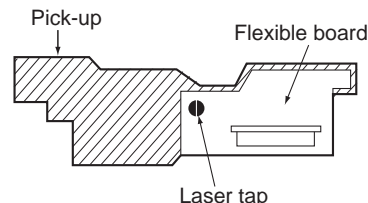

3-3 Precaution during adjustment

- 1) Perform the adjustment and confirmation marked with "O" in the order shown in the table when the parts below are replaced.

ADJUSTMENT

- 2) In the test mode, perform the adjustment. After adjustment is completed, cancel the test mode.

	Optical pick-up	BD board		
		IC6	D101	IC1,IC2,IC10
1. Temperature compensation offset adjustment	X	O	O	O
2. Laser power adjustment	O	O	X	O
3. Traverse adjustment	O	O	X	O
4. Focus bias adjustment	O	O	X	O
5. Error rate confirmation	O	O	X	O

- 3) Perform the adjustment in the order described.
 4) Use the following tools and measurement equipment.
- CD test disc TGYS-1
 - Laser power meter
 - Oscilloscope (with bandwidth of more than 40 MΩ)
(Calibrate the probe before measurement.)
 - Digital voltmeter
 - Thermometer
- 5) Take care that VC and GND (ground) are not connected on the oscilloscope when two or more signals are monitored on the oscilloscope. (VC and GND are short-circuited in this case.)

Note : The "#" display on the screen indicates an arbitrary figure.

3-4 Creating the recordable continuous recording disc

This disc is used for focus bias adjustment and error rate confirmation. How to create the recordable continuous recording disc is described below.

1. Insert a commercial recordable disc (blank disc).
2. Turn the SHUTTLE to display "CREC MODE."
3. Press the PLAY key to display "CREC MID".
4. After pressed the PLAY key, a display indicates "CREC(0300)" and the recording begins.
5. Terminate the recording within five minutes.
6. Press the STOP key to stop the recording.
7. Press the EJECT key to take out the recordable disc.

As a result, a continuously recorded disc can be created for focus bias adjustment and error rate confirmation.

Note : Take care that no vibration is applied during continuous recording.

3-5 Laser power adjustment

Connection :

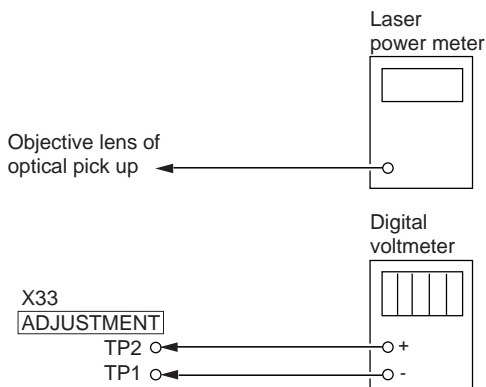

Adjustment :

1. Put the laser power meter on the objective lens of the optical pick-up. Connect the digital voltmeter to TP1 and TP2.
 2. Turn the SHUTTLE to display "LDPWR ADJU".
(Laser power : For adjustment use)
 3. Press the PLAY key to display "(0.9mW)\$##".
 4. Adjust to turn SHUTTLE so that the laser power meter reads 0.86 - 0.94mW.
Set range 10mW of the laser power meter, then save to press PLAY key.
 5. "(7.0mW)\$##" is displayed.
 6. Adjust to turn the SHUTTLE so that laser power meter reads 6.9-7.1mW, then save to press PLAY key.
("LDPWR<\$##" is displayed momentarily.)
- ※ Don't output the laser power of 7.0mW more than 15sec.
7. Next turn the SHUTTLE to display "LDPWR CHEC".
 8. Press PLAY key to display "(0.9mW)\$##". Check the laser power meter reads 0.85-0.95mW.
 9. Next set range 10mW of the laser power meter, then press PLAY key to display "(7.0mW)\$##". Confirm that the laser power meter and digital voltmeter at that time read the specified value.

Specification :

Reading of laser power meter : 7.0 ± 0.1 mW

Reading of digital voltmeter : Optical pick-up indication value $\pm 10\%$

(Optical pick-up label)

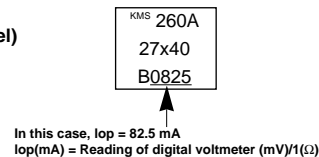

10. Press the PLAY key to display "LDPWR CHEC" and stop the laser emission. (The STOP key can be pressed at any time to stop the laser emission.)

Note : The "#" display on the screen indicates an arbitrary figure.

3-6 Traverse Adjustment

Connection :

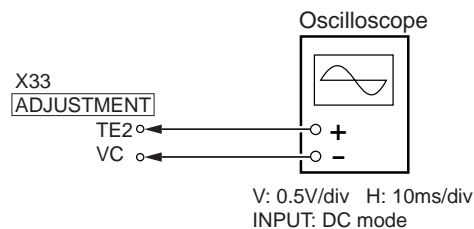

Adjustment :

1. Connect the oscilloscope to (TE2) and (VC) on the X33 board.
2. Insert a commercial recordable disc.
3. Turn the SHUTTLE to display "EFBAL ADJU".

ADJUSTMENT

- Press the PLAY key to display "EFBAL MO-W" and after that press the PLAY key again to display "EF=\$##MOW".
- Turn the SHUTTLE so that the waveform on the oscilloscope satisfies the specified value. (When the SHUTTLE is turned, the #-marked figure in "EF=\$##" changes and the waveform also changes.) During this adjustment, the oscilloscope changes in units of about 3%. Adjust so that the waveform comes nearest to the specified value. (MO groove read power traverse adjustment)

(Traverse waveform)



Specification : A = B

- Press the PLAY key to display "EFB=##XSA" momentarily. After that, "EF=\$##MOR" is displayed. (Laser power READ power, focus servo ON, tracking servo OFF, and spindle(S) servo ON.)
- Turn the SHUTTLE so that the waveform on the oscilloscope satisfies the specified value. (When the SHUTTLE is turned, the #-marked figure in "EF=\$##" changes and the waveform also changes.) During this adjustment, the oscilloscope changes in units of about 2%. Adjust so that the waveform comes nearest to the specified value. (MO groove read power traverse adjustment)

(Traverse waveform)



Specification : A = B

- Press the PLAY key to display "EFB=##XSA" momentarily and save the adjustment result in nonvolatile memory. After that, "EFBAL MO-P" is displayed.
- Press PLAY key to display "EF=\$##MOP". (A pick-up moves automatically to pit block area.)
- Turn the SHUTTLE so that the waveform on the oscilloscope comes near to the specified value. During this adjustment, the waveform changes in units of about 2%. Adjust so that the waveform comes nearest to the specified value.

(Traverse waveform)



Specification : A = B

- Press the PLAY key to display "EFB=##XSA" momentarily and save the adjustment result in nonvolatile memory. After that, "EFBAL CHAN" is displayed. The disc rotation stops automatically.

Note : The "#" display on the screen indicates an arbitrary figure.

- Press the EJECT key to take out a recordable disc.
- Insert test disc TGYS-1.
- Press the PLAY key to display "EF=\$##CD". A servo is established automatically.
- Turn the SHUTTLE so that the waveform on the oscilloscope comes near to the specified value. During this adjustment, the waveform changes in units of about 2%. Adjust so that the waveform comes nearest to the specified value.

(Traverse waveform)



Specification : A = B

- Press the PLAY key to display "EFB=##XSA" momentarily and save the adjustment result in nonvolatile memory. After that, "EFBAL ADJU" is displayed.
- Press the EJECT key to take out test disc TGYS-1.

Notes :

- Data is erased during MO write when a recorded disc is used for this adjustment.
- If the traverse waveform is difficult to be monitored, connect an oscilloscope as shown in the figure below.

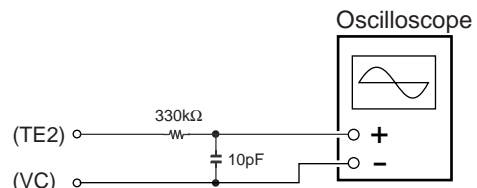

3-7 Focus bias adjustment

Connection :

- Insert a continuously recorded disc (refer to 3-4, "Creating the recordable continuous recording disc").
- Turn the SHUTTLE to display "CPLAY MODE".
- Press the PLAY key to display "CPLAY MID".
- Press the STOP key when "C=**** a=**" is displayed.
- Turn the SHUTTLE to display "FBIAS ADJU".
- Press the PLAY key to display "a=## ####". The four-digit figure indicates the C1 error rate, and the two-digit figure after "a=" indicates the focus bias value.

ADJUSTMENT

7. Turn the SHUTTLE clockwise and detect the focus bias value in which the C1 error rate becomes 220.
8. Press the PLAY key to display "b=## #####".
9. Turn the SHUTTLE counterclockwise and detect the focus bias value in which the C1 error rate becomes 220.
10. Press the PLAY key to display "C=## #####".
11. Confirm that the C1 error rate at that time is less than 50, then press the PLAY key.
12. The display appears "**-**-**" (X" momentarily and save the adjustment result in nonvolatile memory. After that "FBIAS ADJU" is displayed.
13. Press the EJECT key to take out a continuous recording disc.

Notes :

1. The relation between the C1 error and focus bias value is shown in the figure below. Points "a" and "b" in the figure are detected by the above adjustment. Focal position "C" is automatically obtained from points "a" and "b" by calculation.
2. The C1 error rate fluctuates. Therefore, perform the adjustment according to the observed mean value.

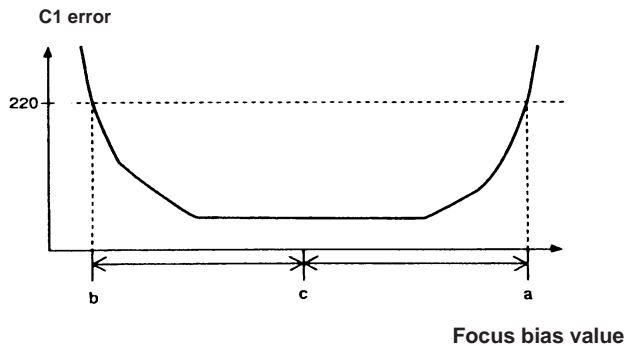

3-8 Error rate confirmation

3-8-1 CD error rate confirmation

Confirmation :

1. Insert test disc TGYS-1.
2. Turn the SHUTTLE to display "CPLAY MODE".
3. Press the PLAY key to display "CPLAY MID".
4. "C=##### a=##" is displayed.
5. Confirm that the C1 error rate is less than 20.
6. Press the STOP key to stop the playback, then press the EJECT key to take out a test disc.

3-8-2 MO error rate confirmation

1. Insert a continuously recorded disc (refer to 3-4, "Creating the recordable continuous recording disc")
2. Turn the SHUTTLE to display "CPLAY MODE".
3. Press the PLAY key to display "CPLAY MID".
4. "C=##### a=##" is displayed.
5. Confirm that the C1 error rate is less than 50 and that ADIP error rate is 00.
6. Press the STOP key to stop the playback, then press the EJECT key to take out a test disc.

Note : The "#" display on the screen indicates an arbitrary figure.

PC BOARD(Component side view)

MD MECHANISM UNIT (X33-1100-00)

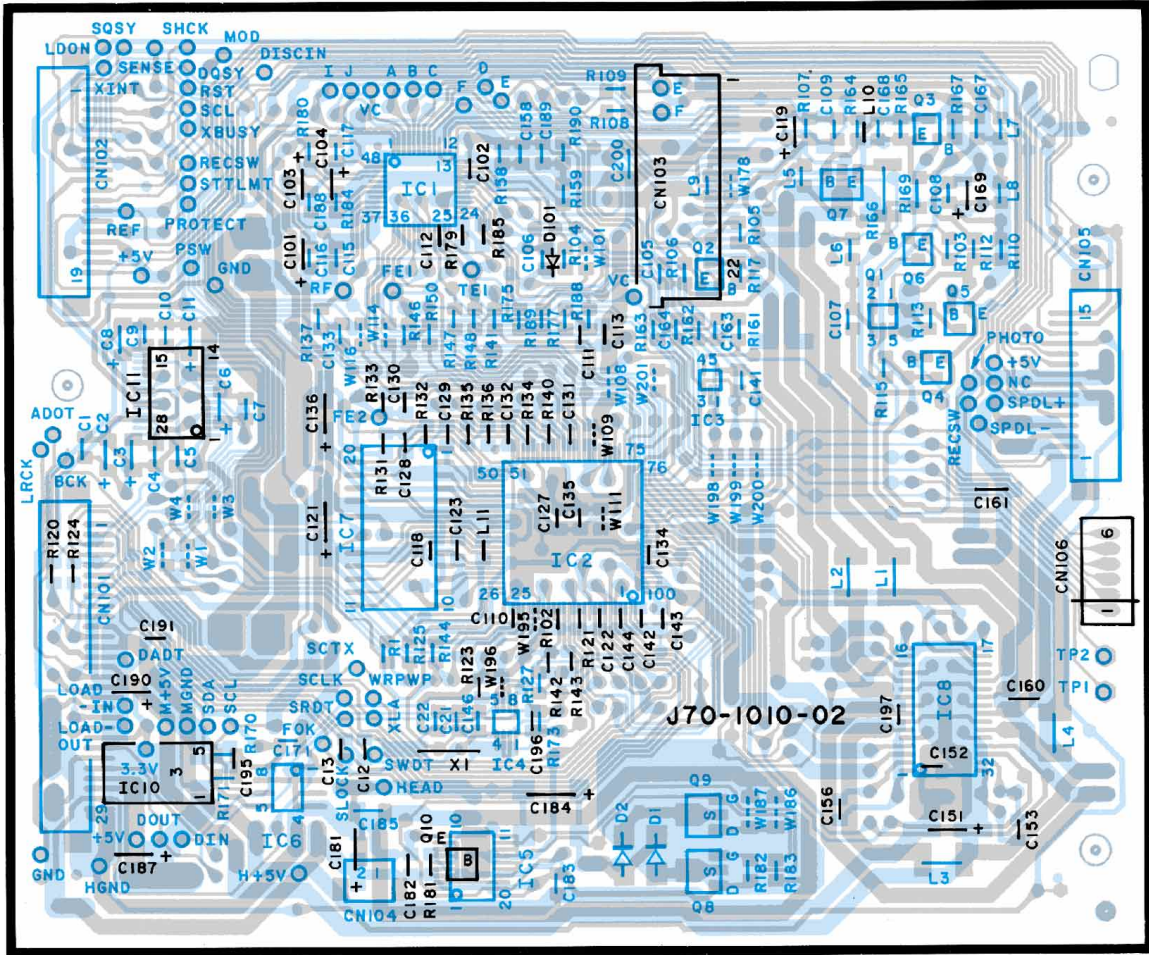

MD CONTROL UNIT (X29-2580-00) (A/2)

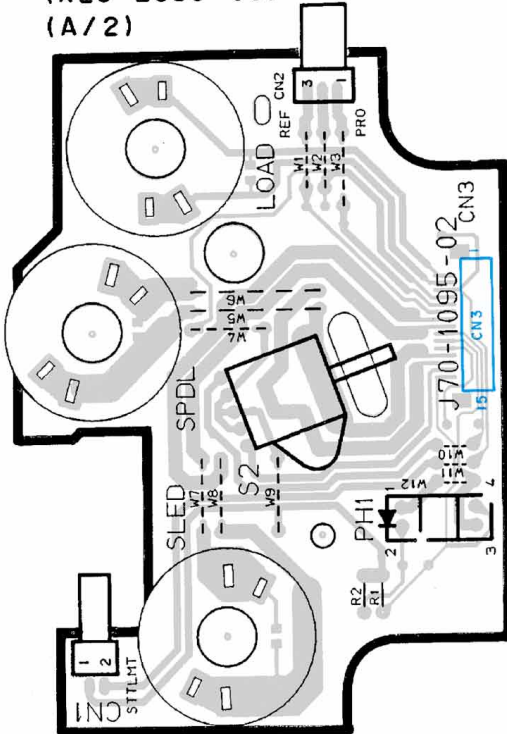

(X29) (B/2)

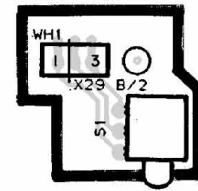

PC BOARD(Component side view)

(X25-6012-71) (A/3)

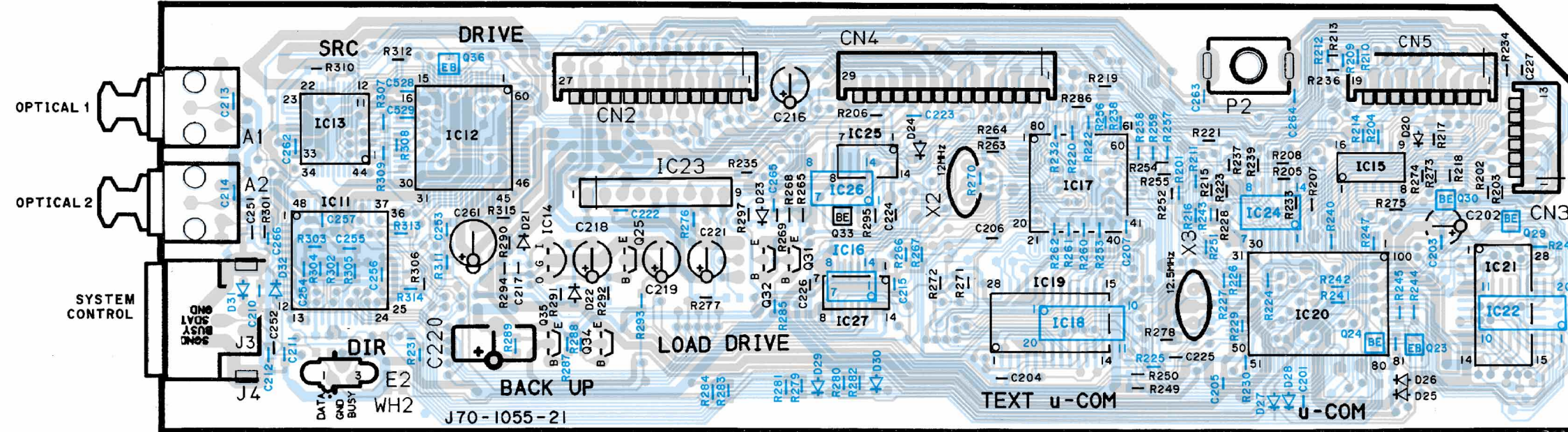

X14 B/5

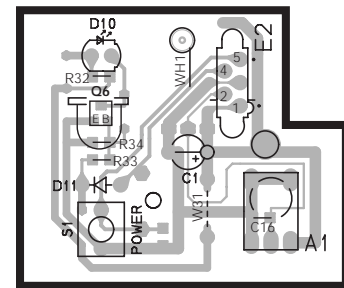

X14 E/5

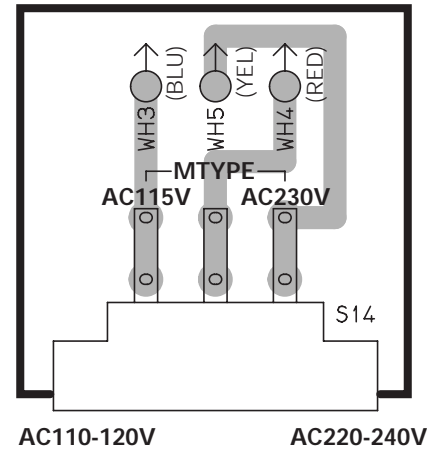

X14 D/5

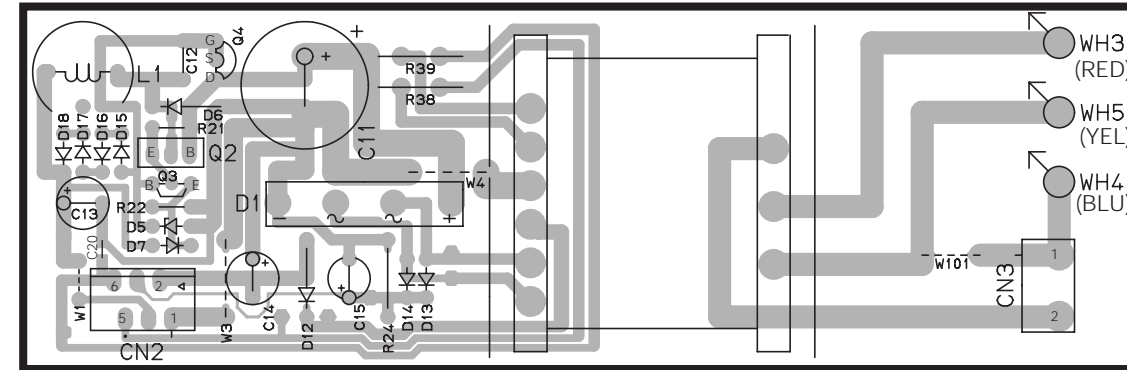

X14-4702-70 A/5

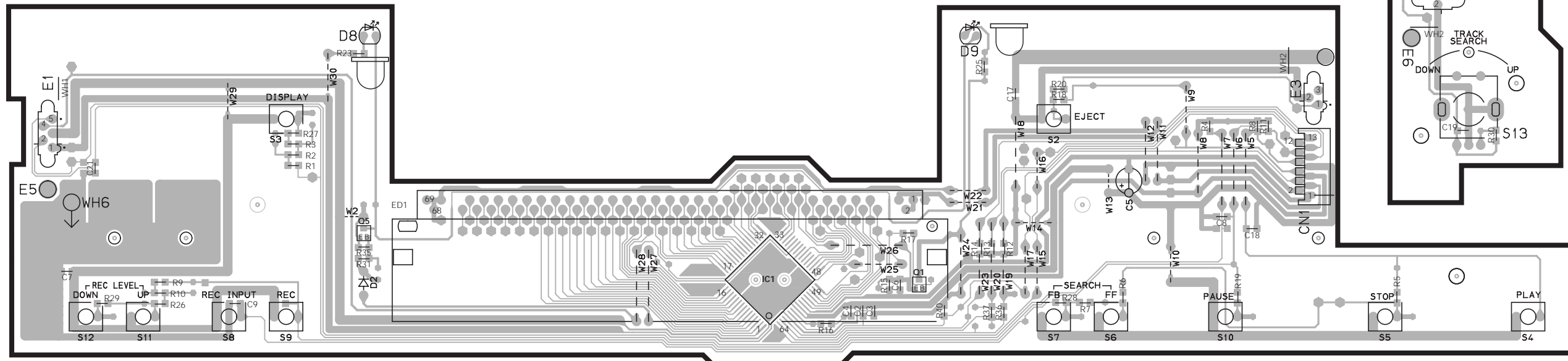

X14 C/5

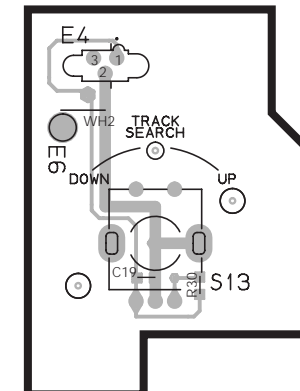

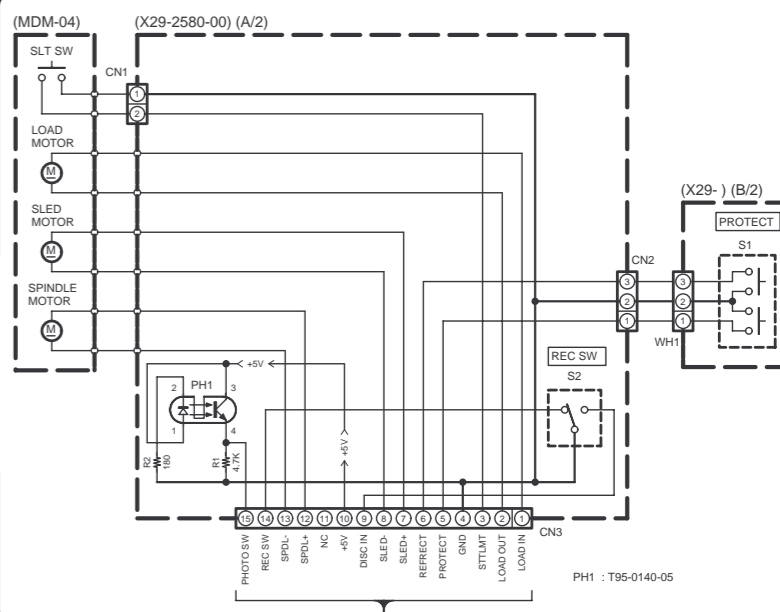
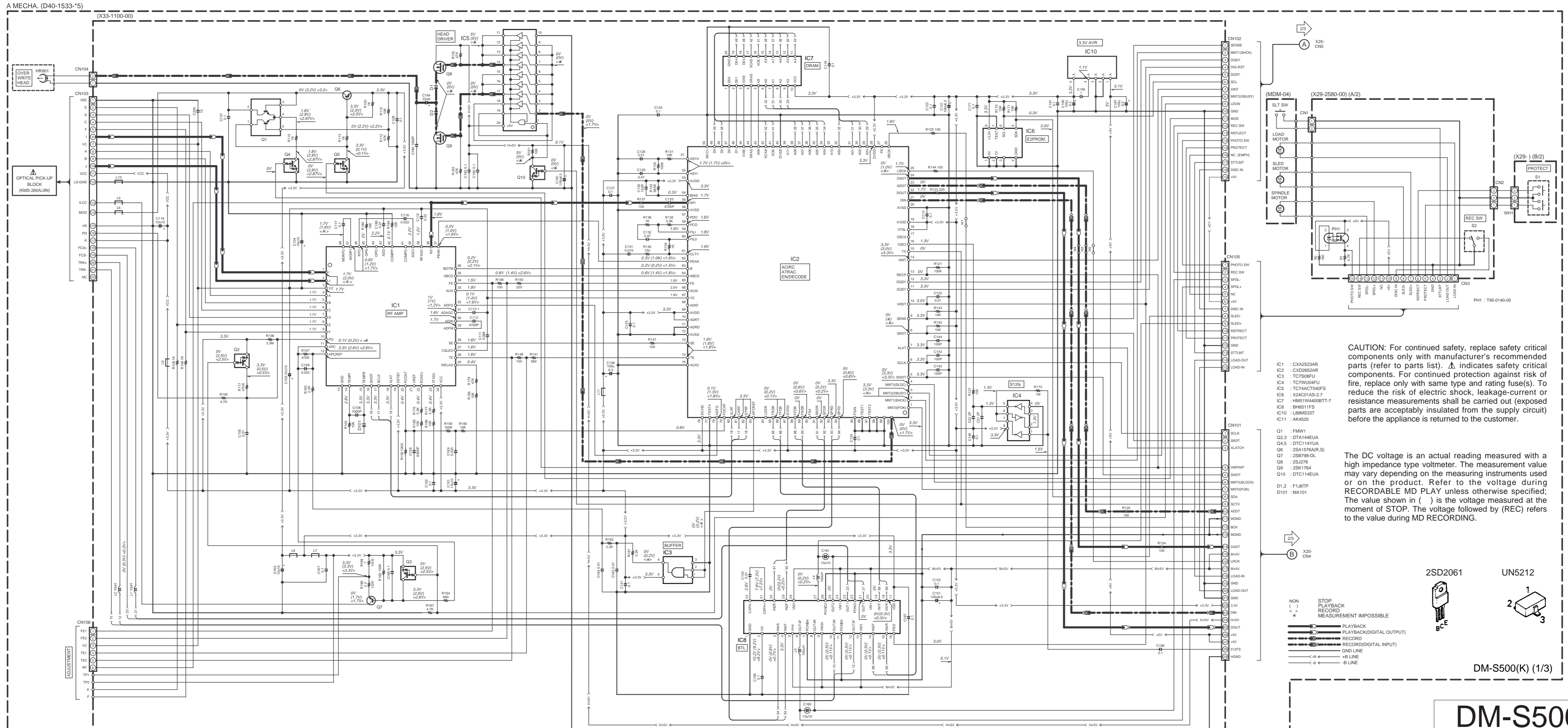

CAUTION: For continued safety, replace safety critical components only with manufacturer's recommended parts (refer to parts list). **⚠** indicates safety critical components. For continued protection against risk of fire, replace only with same type and rating fuse(s). To reduce the risk of electric shock, leakage-current or resistance measurements shall be carried out (exposed parts are acceptably insulated from the supply circuit) before the appliance is returned to the customer.

The DC voltage is an actual reading measured with a high impedance type voltmeter. The measurement value may vary depending on the measuring instruments used or on the product. Refer to the voltage during RECORDABLE MD PLAY unless otherwise specified; The value shown in () is the voltage measured at the moment of STOP. The voltage followed by (REC) refers to the value during MD RECORDING.

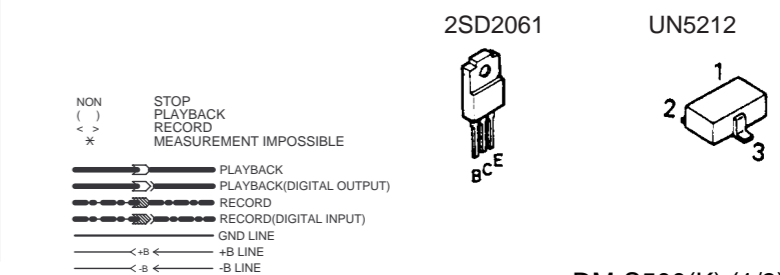

DM-S500
KENWOOD

Y22-7501-00

DM-S500(K) (1/3)

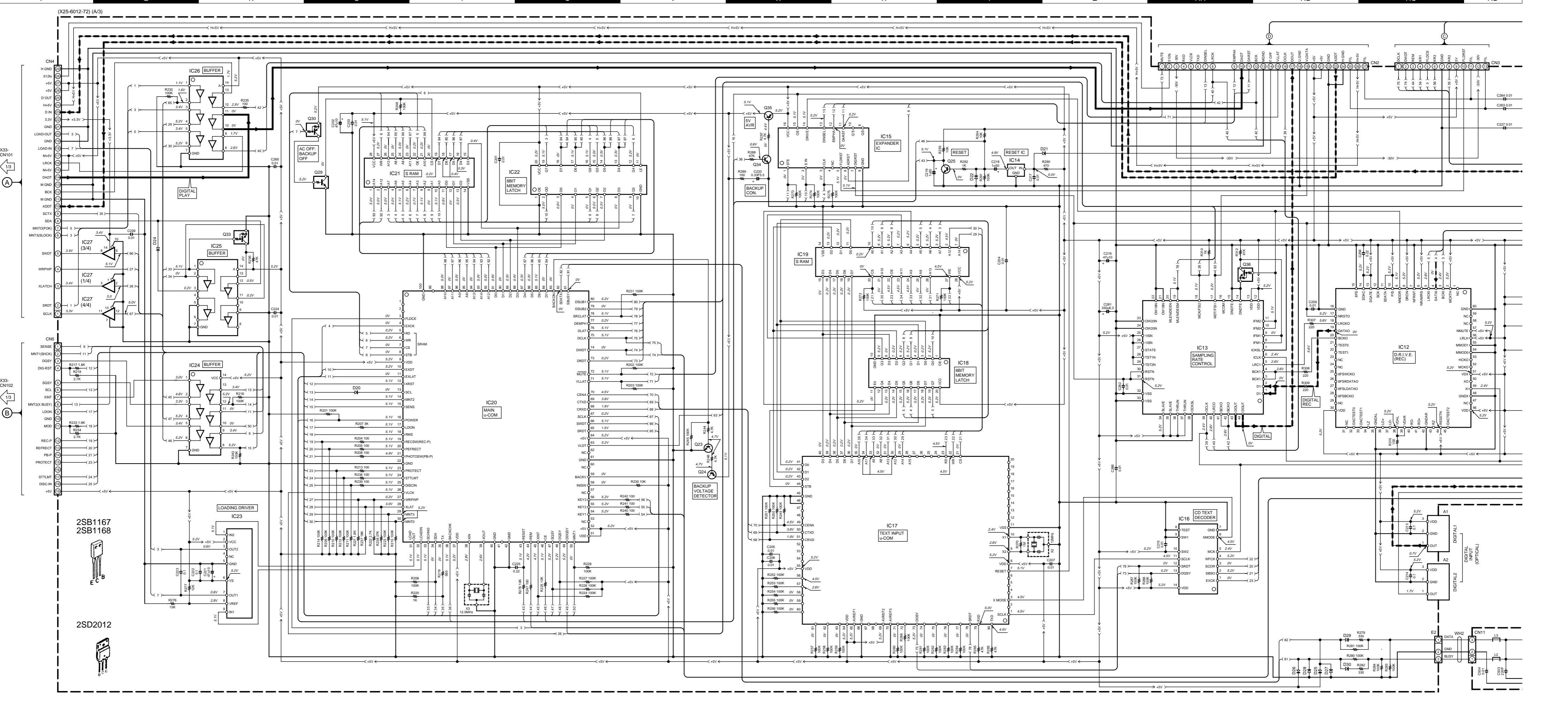

(X25-6012-72) (A/3)

X33-CN101

X33-CN102

2SB1167
2SB1168

2SD2012

1

2

3

4

5

6

7

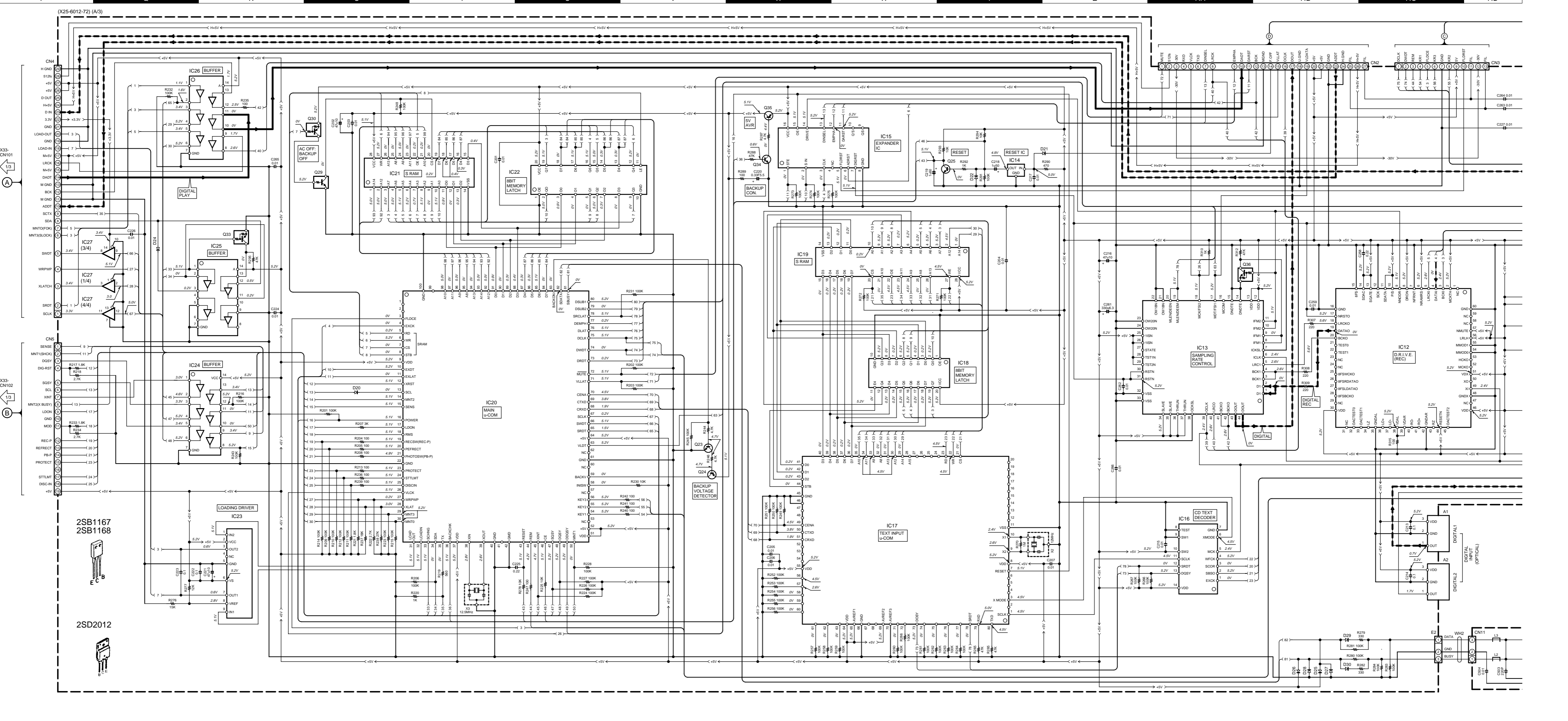

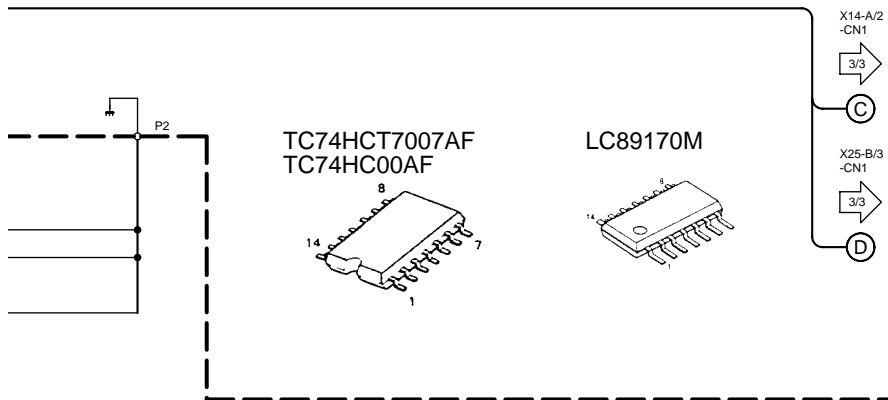

CAUTION: For continued safety, replace safety critical components only with manufacturer's recommended parts (refer to parts list). Δ indicates safety critical components. For continued protection against risk of fire, replace only with same type and rating fuse(s). To reduce the risk of electric shock, leakage-current or resistance measurements shall be carried out (exposed parts are acceptably insulated from the supply circuit) before the appliance is returned to the customer.

The DC voltage is an actual reading measured with a high impedance type voltmeter. The measurement value may vary depending on the measuring instruments used or on the product. Refer to the voltage during RECORDABLE MD PLAY unless otherwise specified; The value shown in () is the voltage measured at the moment of STOP. The voltage followed by (REC) refers to the value during MD RECORDING.

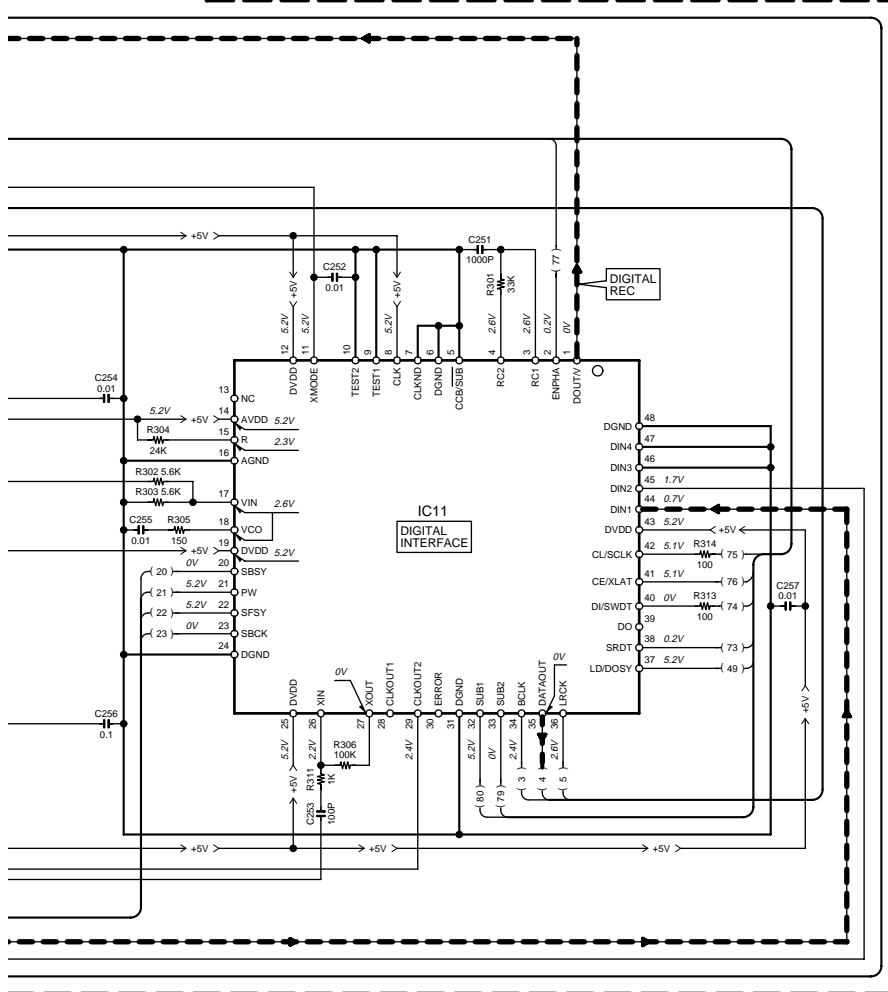

TA8409S

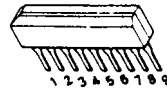

CXA2523AR
LC8904Q

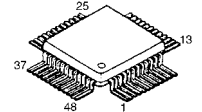

2SA954
2SC2003

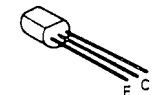

2SA1048
2SC2458

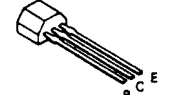

2SA1309A
2SC3311A

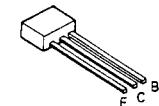

NJM062M
NJM2115M

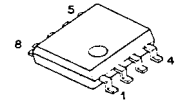

- IC11 : LC8904Q
- IC12 : KAN03
- IC13 : SM5844AF
- IC14 : PST993D-T
- IC15 : BU4094BCF
- IC16 : LC89170M
- IC17 : uPD784035GC806
- IC18,22 : HD74HC373FPPEL
- IC19,21 : HM62256BLFP-8T
- IC20 : uPD784215GF506
- IC23 : TA8409S
- IC24,26 : TC74HCT7007AF
- IC25 : HD74HCT126FPPEL
- IC27 : TC74VHC125F
- Q23 : 2SC4177(L5,L6) or 2SC4116(Y,GR)
- Q24 : 2SA1586(Y,GR) or 2SA1611(M5,M6)
- Q25,34 : 2SC3311A(Q,R) or 2SC2458(Y,GR)
- Q29 : UN5216 or DTC143TU
- Q30 : UN5112 or DTA124EUA
- Q33,36 : UN5212 or DTC124EUA
- Q35 : 2SA1048(Y,GR) or 2SA1309A(Q,R)

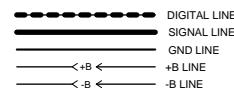

FMW1

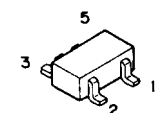

BU4094BCF

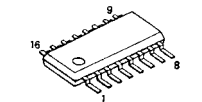

- DTA144EUA
- DTC114YUA
- DTC143TU
- UN5216
- 2SA1586
- 2SC4116

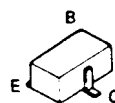

TC7SU04F

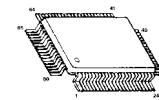

LM431AIZ

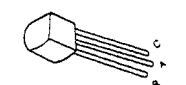

CXD2652AR

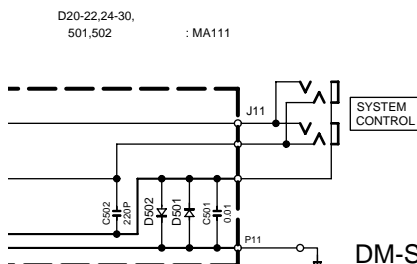
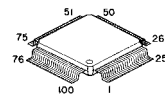

DM-S500 (2/3)

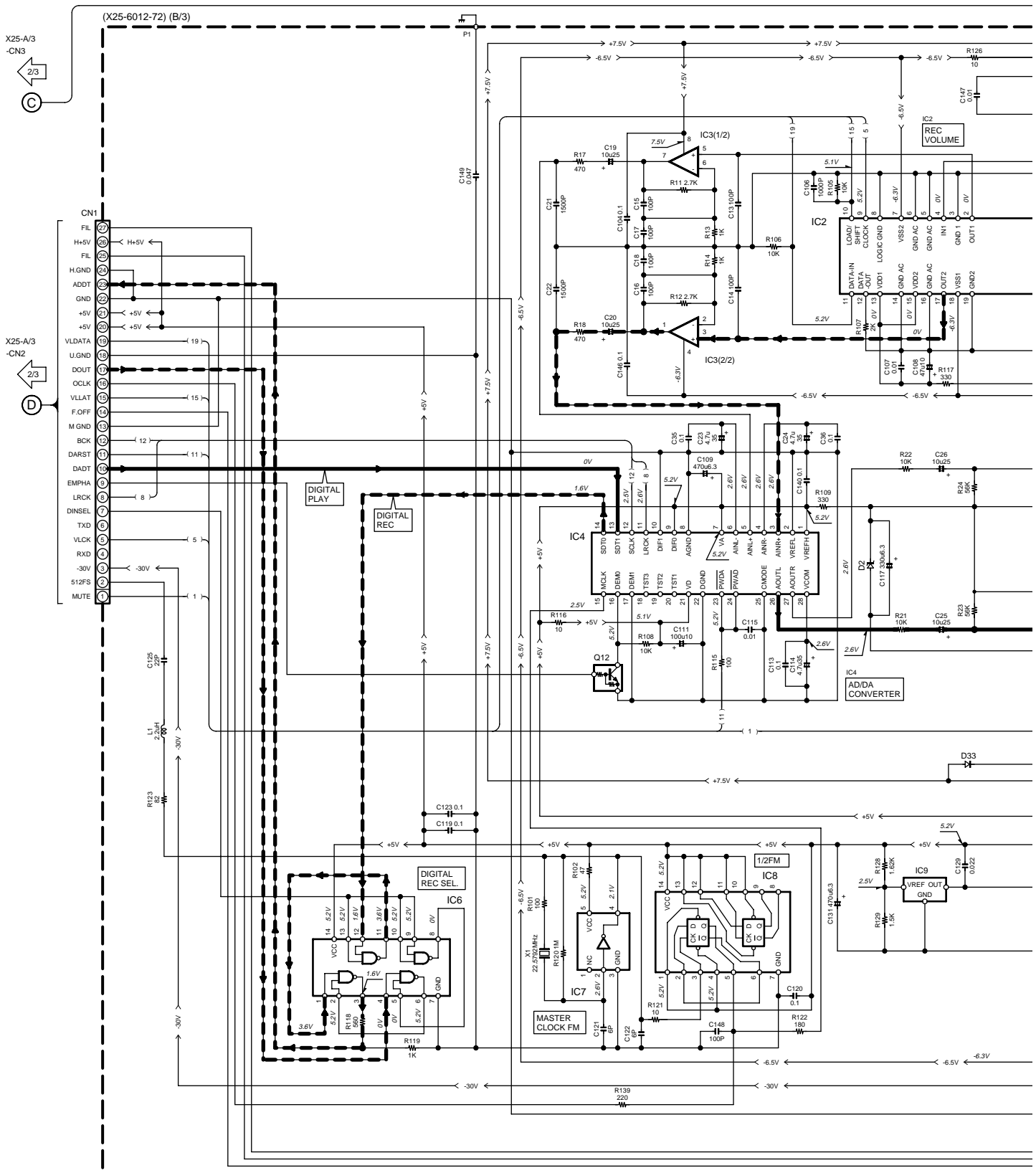

HD74HCT126FPEL
HD74HC74FPEL

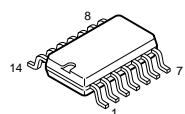

L88MS33T

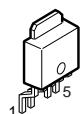

TC7WU04FU

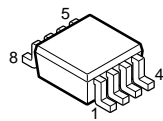

TC74ACT540FS

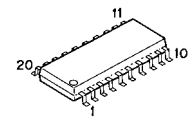

2SB798-DL

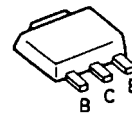

TC7S08FU

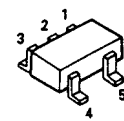

1
2
3
4
5
6
7

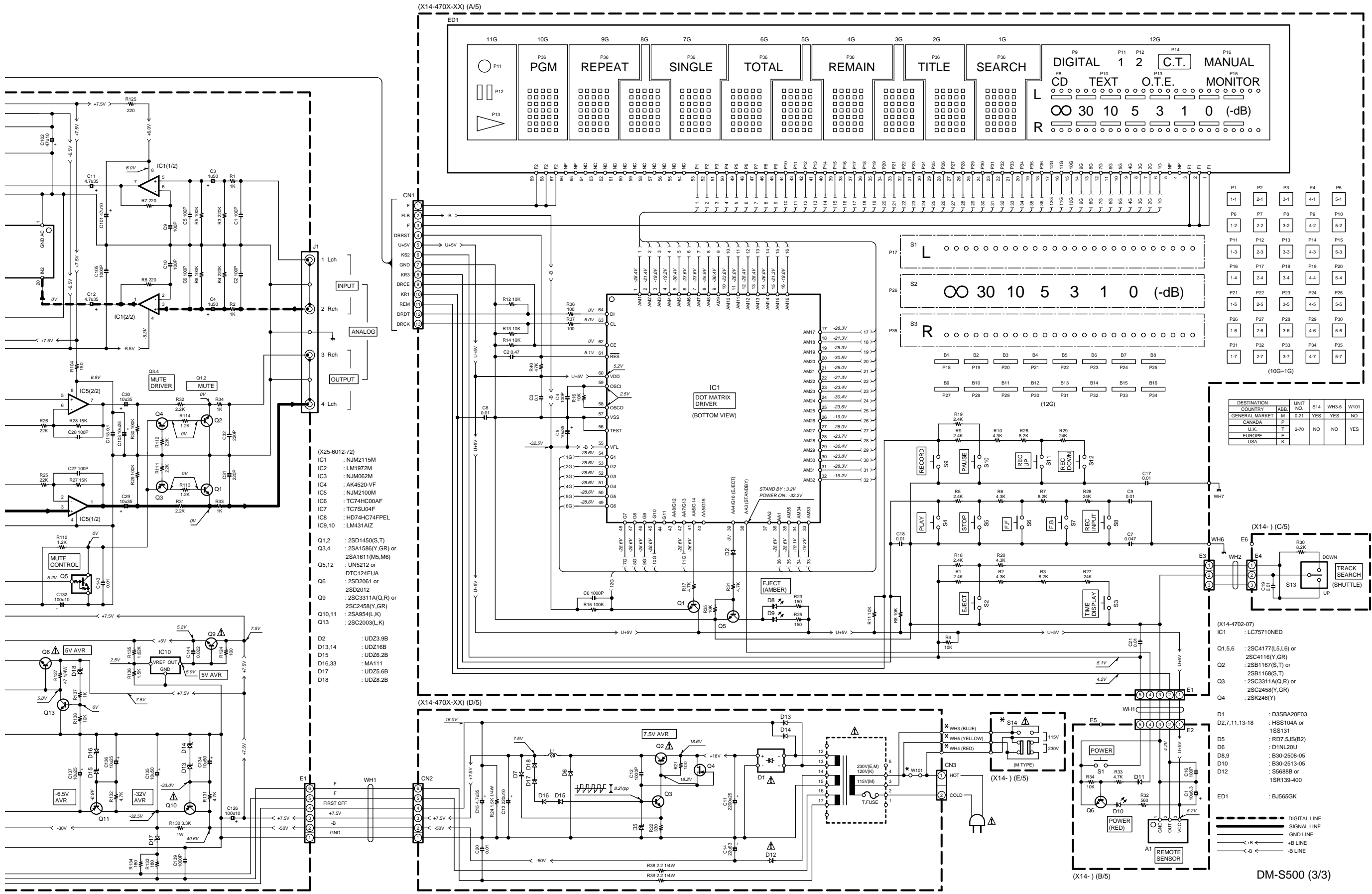

CAUTION: For continued safety, replace safety critical components only with manufacturer's recommended parts (refer to parts list). Δ indicates safety critical components. For continued protection against risk of fire, replace only with same type and rating fuse(s). To reduce the risk of electric shock, leakage-current or resistance measurements shall be carried out (exposed parts are acceptably insulated from the supply circuit) before the appliance is returned to the customer.

The DC voltage is an actual reading measured with a high impedance type voltmeter. The measurement value may vary depending on the measuring instruments used or on the product. Refer to the voltage during RECORDABLE MD PLAY unless otherwise specified; The value shown in () is the voltage measured at the moment of STOP. The voltage followed by (REC) refers to the value during MD RECORDING.

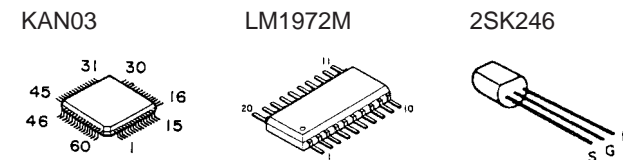

Y22-7501-00

DM-S500
KENWOOD

DM-S500

EXPLODED VIEW (MD MECHANISM)

- | | | | |
|--------------------------------|---------------|-------------------------------------|---------------|
| AA $\varnothing 2.6 \times 10$ | : N09-2817-05 | AE M1.7x4.5 | : N39-1745-46 |
| AB M1.7x2 | : N09-3104-05 | AF $\varnothing 2 \times 4$ | : N82-2004-46 |
| AC M1.7x3 | : N09-3279-05 | AG $\varnothing 2 \times 8$ | : N89-2008-46 |
| AD $\varnothing 2 \times 6$ | : N09-4145-05 | AH $\varnothing 2.6 \times 6$ (BLK) | : N89-2606-45 |

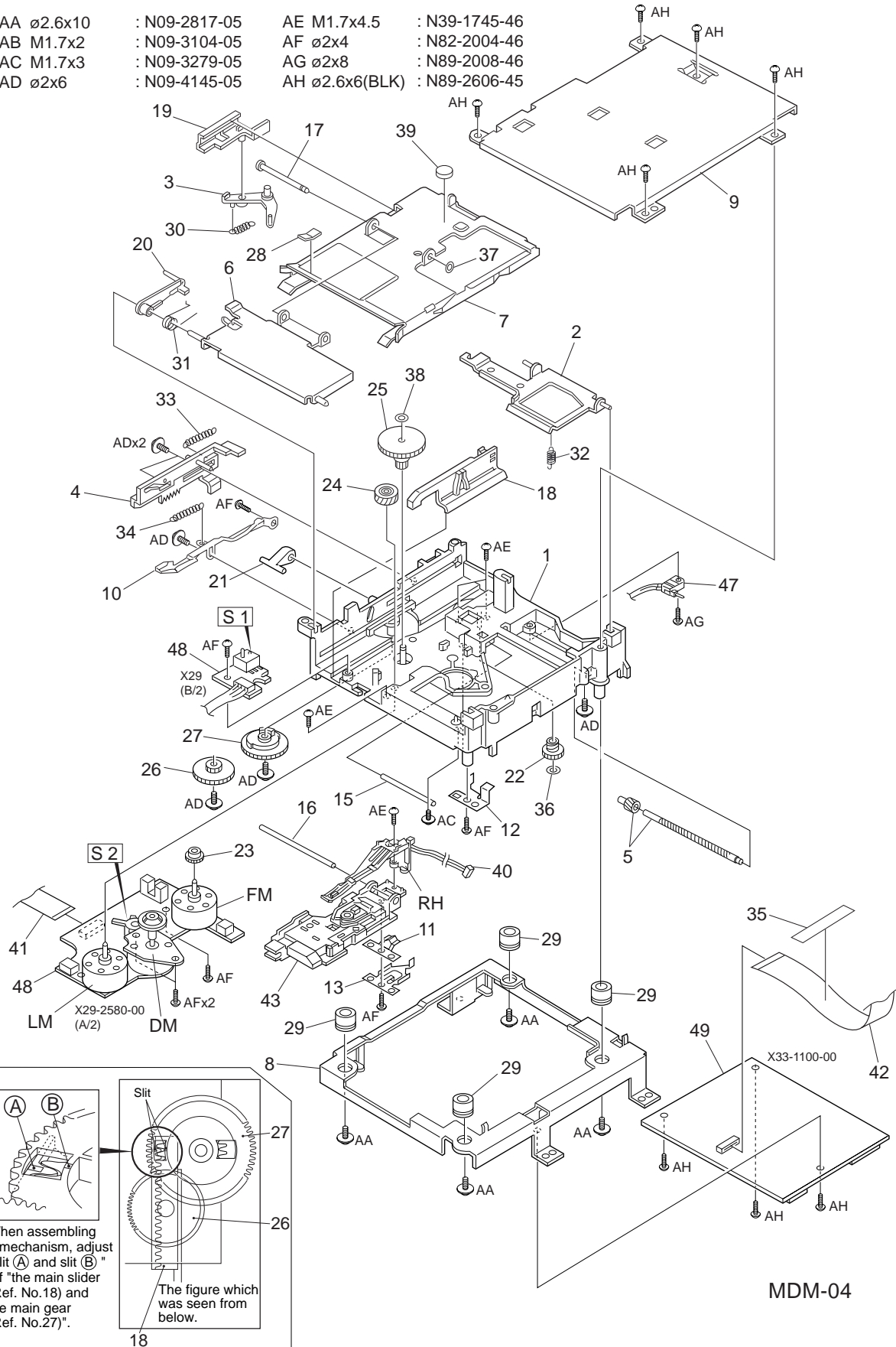

When assembling a mechanism, adjust "slit (A) and slit (B)" of "the main slider (Ref. No.18) and the main gear (Ref. No.27)".

The figure which was seen from below.

MDM-04

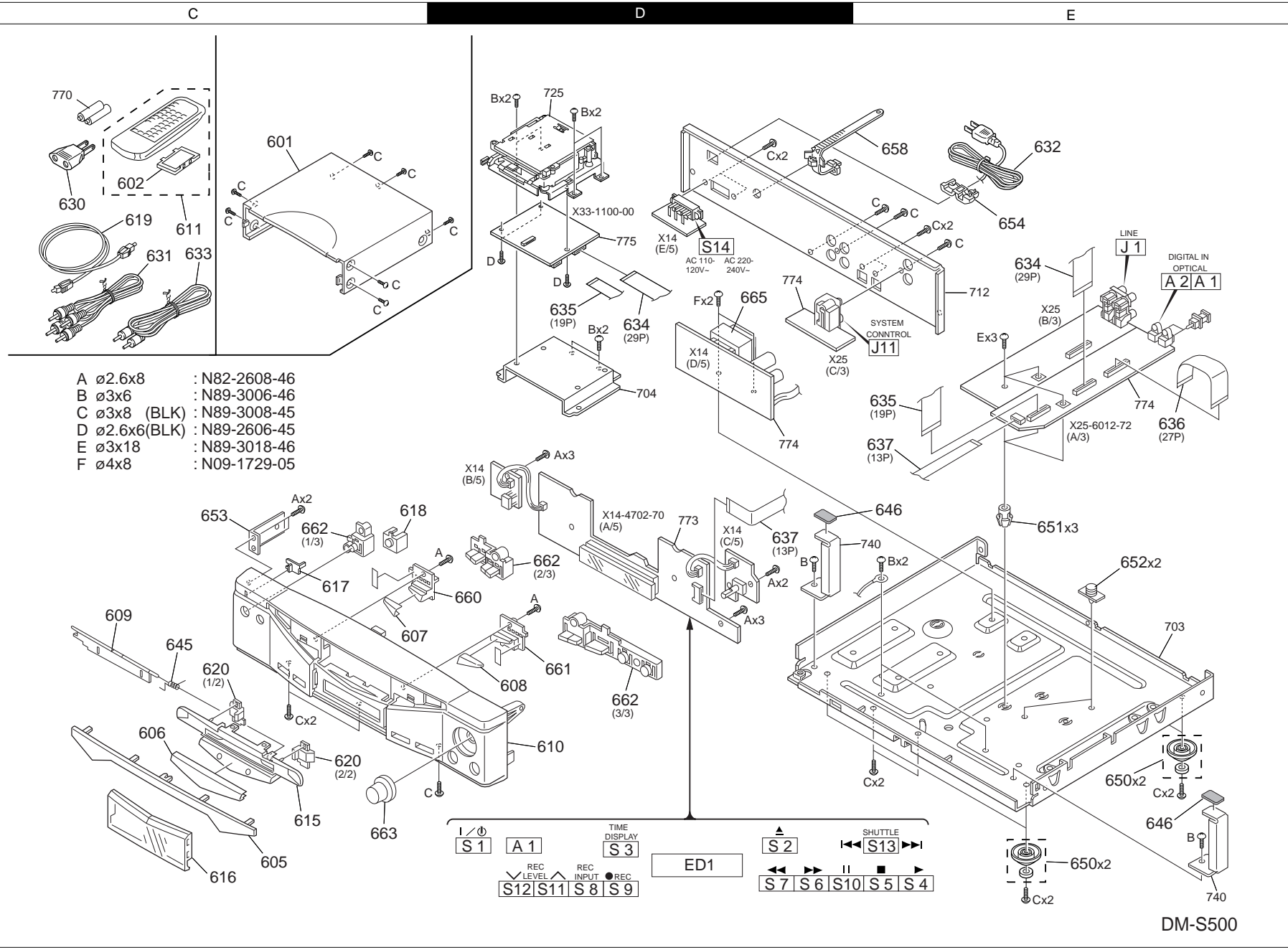

DM-S500

* New Parts

Parts without **Parts No.** are not supplied.
Les articles non mentionnés dans le **Parts No.** ne sont pas fournis.
Teile ohne **Parts No.** werden nicht geliefert.

①

Ref. No	Add-ress	New Parts	Parts No.	Description	Desti-nation	Re-marks
DM-S500						
601	1C		A01-3444-01	METALLIC CABINET		
602	1C		A09-0356-08	BATTERY COVER		
605	2C	*	A21-3620-02	DRESSING PANEL		
606	2C	*	A21-3621-03	DRESSING PANEL		
607	2C	*	A21-3622-03	DRESSING PANEL		
608	2D	*	A21-3623-03	DRESSING PANEL		
609	2C	*	A29-0891-04	PANEL	KP	
610	2D	*	A60-1290-01	PANEL	MTE	
610	2D	*	A60-1339-01	PANEL		
611	1C	*	A70-1187-05	REMOTE CONTROLLER ASSY		
615	2C	*	B07-2395-02	ESCUTCHEON		
616	2C		B10-2386-12	FRONT GLASS		
617	2C		B12-0311-04	INDICATOR		
618	2C		B12-0329-04	INDICATOR		
619	1C		B19-1529-05	OPTICAL FIBER		
620	2C	*	B19-1583-14	LIGHTING BOARD		
-			B46-0310-03	WARRANTY CARD	TE	
-			B46-0319-00	QUESTIONNAIRE CARD	T	
-			B46-0328-03	WARRANTY CARD	k	
-			B46-0336-03	WARRANTY CARD	P	
-			B58-0945-03	CAUTION CARD	T	
-			B58-0964-13	CAUTION CARD	k	
-			B58-0965-13	CAUTION CARD	T	
-			B58-0966-13	CAUTION CARD	ME	
-			B58-0967-03	CAUTION CARD	P	
-		*	B60-3554-00	INSTRUCTION MANUAL(ENG)	KPMT	
-		*	B60-3555-00	INSTRUCTION MANUAL(G/N)	E	
-		*	B60-3556-00	INSTRUCTION MANUAL(FRN)	PE	
-		*	B60-3557-00	INSTRUCTION MANUAL(SPN)	ME	
-		*	B60-3558-00	INSTRUCTION MANUAL(TWN)	M	
-		*	B60-3698-00	INSTRUCTION MANUAL(ITL)	E	
Δ 630	1C		E03-0115-05	AC PLUG ADAPTER	M	
631	1C		E30-0505-05	AUDIO CORD		
Δ 632	1E		E30-2592-15	AC POWER CORD	ME	
Δ 632	1E		E30-2650-05	AC POWER CORD	KP	
Δ 632	1E		E30-2721-05	AC POWER CORD	T	
633	1C		E30-2733-05	CORD WITH PLUG		
634	1D,1E	*	E35-2030-05	FLAT CABLE 29P		
635	1D,1E	*	E35-2031-05	FLAT CABLE 19P		
636	1E	*	E35-2032-05	FLAT CABLE 27P		
637	2D,1E	*	E35-2033-05	FLAT CABLE 13P		
645	2C		G01-4036-04	TORSION COIL SPRING		
646	2E		G11-2382-04	CUSHION		
-		*	H10-7407-12	POLYSTYRENE FOAMED FIXTURE		
-		*	H10-7408-12	POLYSTYRENE FOAMED FIXTURE		
-		*	H12-2384-04	PACKING FIXTURE	T	
-		*	H20-0568-04	PROTECTION COVER	M	
-		*	H25-0232-04	PROTECTION BAG (235X350X0.03)	KPME	
-		*	H25-0651-04	PROTECTION BAG	T	
-		*	H25-0661-04	PROTECTION BAG	KPTE	
-		*	H50-2650-04	ITEM CARTON CASE	KPME	
-		*	H50-2651-04	ITEM CARTON CASE	T	
650	2E		J02-1188-13	FOOT		
651	2E		J19-2598-05	HOLDER		

L : Scandinavia K : USA P : Canada R : Mexico
Y : PX(Far East, Hawaii) T : Europe E : Europe G : Germany
Y : AAFES(Europe) X : Australia M : Other Areas

Δ indicates safety critical components.

* New Parts

Parts without **Parts No.** are not supplied.
Les articles non mentionnés dans le **Parts No.** ne sont pas fournis.
Teile ohne **Parts No.** werden nicht geliefert.

②

Ref. No	Add-ress	New Parts	Parts No.	Description	Desti-nation	Re-marks
652	2E		J19-3721-14	UNIT HOLDER		
653	2C		J21-6480-04	MOUNTING HARDWARE		
654	1E		J42-0083-05	POWER CORD BUSHING		
658	1E		J61-0101-05	WIRE BAND		
-			J61-0307-05	WIRE BAND		
660	2D		K29-6677-03	KNOB		
661	2D		K29-6679-03	KNOB		
662	2C,2D	*	K29-6835-12	KNOB		
663	2C		K29-6945-04	KNOB		
Δ 665	1D		L07-2393-15	POWER TRANSFORMER	TE	
Δ 665	1D	*	L07-2452-05	POWER TRANSFORMER	KP	
Δ 665	1D	*	L07-2453-05	POWER TRANSFORMER	M	
DISPLAY (X14-4702-70)						
D8 ,9			B30-2508-05	LED(AMBER,D=3,P=2)		
D10			B30-2513-05	LED(RED-635NM,3)		
C1			C90-3209-05	ELECTRO 10UF 6.3WV		
C2			CK73FF1C474Z	CHIP C 0.47UF Z		
C3			CK73FB1E104K	CHIP C 0.10UF K		
C4			CC73FCH1H101J	CHIP C 100PF J		
C5			C90-3244-05	ELECTRO 10UF 35WV		
C6			CC73FSL1H102J	CHIP C 1000PF J		
C7			CK73FB1E473K	CHIP C 0.047UF K		
C8 ,9			CK73FB1H103K	CHIP C 0.010UF K		
C11			CE04KW1E222M	ELECTRO 2200UF 25WV		
C12			CK45FB1H102K	CERAMIC 1000PF K		
C13			CE04KW1A221M	ELECTRO 220UF 10WV		
C14			CE04KW1J220M	ELECTRO 22UF 63WV		
C15			CE04KW1V4R7M	ELECTRO 4.7UF 35WV		
C16			CC73FCH1H101J	CHIP C 100PF J		
C17 -21			CK73FB1H103K	CHIP C 0.010UF K		
CN1			E40-8147-05	FLAT CABLE CONNECTOR		
CN2			E40-4296-05	FLAT CABLE CONNECTOR		
CN3			E40-4245-05	PIN ASSY		
E5 ,6			J11-0808-05	WIRE CLAMPER		
L1			L33-0558-05	CHOKE COIL		
R1			RK73FB2A242J	CHIP R 2.4K J 1/10W		
R2			RK73FB2A432J	CHIP R 4.3K J 1/10W		
R3			RK73FB2A822J	CHIP R 8.2K J 1/10W		
R4			RK73FB2A103J	CHIP R 10K J 1/10W		
R5			RK73FB2A242J	CHIP R 2.4K J 1/10W		
R6			RK73FB2A432J	CHIP R 4.3K J 1/10W		
R7			RK73FB2A822J	CHIP R 8.2K J 1/10W		
R8			RK73FB2A103J	CHIP R 10K J 1/10W		
R9			RK73FB2A242J	CHIP R 2.4K J 1/10W		
R10			RK73FB2A432J	CHIP R 4.3K J 1/10W		
R11 -14			RK73FB2A103J	CHIP R 10K J 1/10W		
R15			RK73FB2A104J	CHIP R 100K J 1/10W		
R16			RK73FB2A103J	CHIP R 10K J 1/10W		
R17			RK73FB2A472J	CHIP R 4.7K J 1/10W		
R18 ,19			RK73FB2A242J	CHIP R 2.4K J 1/10W		
R20			RK73FB2A432J	CHIP R 4.3K J 1/10W		
R23			RK73FB2A151J	CHIP R 150 J 1/10W		
R25			RK73FB2A151J	CHIP R 150 J 1/10W		

L : Scandinavia K : USA P : Canada R : Mexico
Y : PX(Far East, Hawaii) T : Europe E : Europe G : Germany
Y : AAFES(Europe) X : Australia M : Other Areas

Δ indicates safety critical components.

PARTS LIST

DM-S500

* New Parts

Parts without **Parts No.** are not supplied.Les articles non mentionnés dans le **Parts No.** ne sont pas fournis.Teile ohne **Parts No.** werden nicht geliefert.

③

Ref. No	Add-ress	New Parts	Parts No.	Description	Desti-nation	Re-marks
R26			RK73FB2A822J	CHIP R 8.2K J 1/10W		
R27 -29			RK73FB2A243J	CHIP R 24K J 1/10W		
R30			RK73FB2A822J	CHIP R 8.2K J 1/10W		
R31			RK73FB2A472J	CHIP R 4.7K J 1/10W		
R32			RK73FB2A561J	CHIP R 560 J 1/10W		
R33			RK73FB2A472J	CHIP R 4.7K J 1/10W		
R34 ,35			RK73FB2A103J	CHIP R 10K J 1/10W		
R36 ,37			RK73FB2A101J	CHIP R 100 J 1/10W		
R38 ,39			RD14NB2E2R2J	RD 2.2 J 1/4W		
R40			RK73FB2A473J	CHIP R 47K J 1/10W		
S1 -12			S70-0031-05	TACT SWITCH		
S13			S60-0036-05	ROTARY SWITCH		
S14			S62-0001-05	SLIDE SWITCH	M	
Δ D1			D3SBA20F03	DIODE		
D2			HSS104A	DIODE		
D2			1SS131	DIODE		
D5			RD7.5JS(B2)	ZENER DIODE		
D6			D1NL20U	DIODE		
D7			HSS104A	DIODE		
D7			1SS131	DIODE		
D11			HSS104A	DIODE		
D11			1SS131	DIODE		
Δ D12			S5688B	DIODE		
D12			1SR139-400	DIODE		
D13 -18			HSS104A	DIODE		
D13 -18			1SS131	DIODE		
ED1			BJ565GK	INDICATOR TUBE		
IC1			LC75710NED	MOS-IC		
Q1			2SC4116(Y,GR)	TRANSISTOR		
Q1			2SC4177(L5,L6)	TRANSISTOR		
Q2			2SB1167(S,T)	TRANSISTOR		
Δ Q2			2SB1168(S,T)	TRANSISTOR		
Q3			2SC2458(Y,GR)	TRANSISTOR		
Q3			2SC3311A(Q,R)	TRANSISTOR		
Q4			2SK246(Y)	FET		
Q5 ,6			2SC4116(Y,GR)	TRANSISTOR		
Q5 ,6			2SC4177(L5,L6)	TRANSISTOR		
A1			W02-2571-05	OPTIC RECEIVING MODULE		
CONTROL (X25-6012-72)						
C1 ,2			CC73FSL1H101J	CHIP C 100PF J		
C3 ,4			CE04KW1H010M	ELECTRO 1.0UF 50WV		
C5 ,6			CC73FSL1H101J	CHIP C 100PF J		
C9 ,10			CC73FSL1H101J	CHIP C 100PF J		
C11 ,12			CE04KW1V4R7M	ELECTRO 4.7UF 35WV		
C13 -18			CC73FSL1H101J	CHIP C 100PF J		
C19 ,20			CE04KW1E100M	ELECTRO 10UF 25WV		
C21 ,22			CK73FB1H152K	CHIP C 1500PF K		
C23 ,24			CE04KW1V4R7M	ELECTRO 4.7UF 35WV		
C25 ,26			CE04KW1E100M	ELECTRO 10UF 25WV		
C27 ,28			CC73FSL1H101J	CHIP C 100PF J		
C29 ,30			C90-3764-05	ELECTRO 10UF 35WV		
C31 ,32			CC73FSL1H221J	CHIP C 220PF J		
C35 ,36			CK73FB1E104K	CHIP C 0.10UF K		
C101,102			CE04KW1A470M	ELECTRO 47UF 10WV		

L : Scandinavia

K : USA

P : Canada

R : Mexico

Y : PX(Far East, Hawaii)

T : Europe

E : Europe

G : Germany

Y : AAFES(Europe)

X : Australia

M : Other Areas

Δ indicates safety critical components.

* New Parts

Parts without **Parts No.** are not supplied.Les articles non mentionnés dans le **Parts No.** ne sont pas fournis.Teile ohne **Parts No.** werden nicht geliefert.

④

Ref. No	Add-ress	New Parts	Parts No.	Description	Desti-nation	Re-marks
C103			CE04KW1E100M	ELECTRO 10UF 25WV		
C104			CK73FB1E104K	CHIP C 0.10UF K		
C105,106			CK73FB1H102K	CHIP C 1000PF K		
C107			CK73FB1H103K	CHIP C 0.010UF K		
C108			CE04KW1A470M	ELECTRO 47UF 10WV		
C109			CE04KW0J471M	ELECTRO 470UF 6.3WV		
C111			CE04KW1A101M	ELECTRO 100UF 10WV		
C113			CK73FB1E104K	CHIP C 0.10UF K		
C114			CE04KW1V4R7M	ELECTRO 4.7UF 35WV		
C115			CK73FB1H103K	CHIP C 0.010UF K		
C117			CE04KW0J331M	ELECTRO 330UF 6.3WV		
C118-120			CK73FB1E104K	CHIP C 0.10UF K		
C121,122			CC73FCH1H060D	CHIP C 6.0PF D		
C123			CK73FB1E104K	CHIP C 0.10UF K		
C125			CC73FSL1H220J	CHIP C 22PF J		
C126			CE04KW1A101M	ELECTRO 100UF 10WV		
C129			CK73FB1H223K	CHIP C 0.022UF K		
C131			CE04KW0J471M	ELECTRO 470UF 6.3WV		
C132			CE04KW1A101M	ELECTRO 100UF 10WV		
C134,135			CE04KW1H100M	ELECTRO 10UF 50WV		
C136,137			CE04KW1E100M	ELECTRO 10UF 25WV		
C139			CK73FB1H102K	CHIP C 1000PF K		
C140			CK73FB1E104K	CHIP C 0.10UF K		
C143			CK73FB1H103K	CHIP C 0.010UF K		
C144			CK73FB1H223K	CHIP C 0.022UF K		
C146			CK73FB1E104K	CHIP C 0.10UF K		
C147			CK73FB1H103K	CHIP C 0.010UF K		
C148			CC73FSL1H101J	CHIP C 100PF J		
C149			CK73FB1E473K	CHIP C 0.047UF K		
C201			CK73FB1H103K	CHIP C 0.010UF K		
C202			CE04KW1A470M	ELECTRO 47UF 10WV		
C203-207			CK73FB1H103K	CHIP C 0.010UF K		
C213,214			CK73FB1E104K	CHIP C 0.10UF K		
C215			CK73FB1H103K	CHIP C 0.010UF K		
C216			CE04KW1A470M	ELECTRO 47UF 10WV		
C217			CK73FB1H103K	CHIP C 0.010UF K		
C218,219			CE04KW1H010M	ELECTRO 1.0UF 50WV		
C220			C90-3623-05	BACK UP 0.33F 5.5V		
C221			CE04KW1A470M	ELECTRO 47UF 10WV		
C222,223			CK73FB1E104K	CHIP C 0.10UF K		
C224			CK73FB1H103K	CHIP C 0.010UF K		
C225			CK73FF1C224Z	CHIP C 0.22UF Z		
C226,227			CK73FB1H103K	CHIP C 0.010UF K		
C251			CK73FB1H102K	CHIP C 1000PF K		
C252			CK73FB1H103K	CHIP C 0.010UF K		
C253			CC73FSL1H101J	CHIP C 100PF J		
C254,255			CK73FB1H103K	CHIP C 0.010UF K		
C256			CK73FB1E104K	CHIP C 0.10UF K		
C257			CK73FB1H103K	CHIP C 0.010UF K		
C258			CK73FB1C224K	CHIP C 0.22UF K		
C259			CK73FB1H103K	CHIP C 0.010UF K		
C261			CE04KW0J331M	ELECTRO 330UF 6.3WV		
C262-266			CK73FB1H103K	CHIP C 0.010UF K		
C501			CK73FB1H103K	CHIP C 0.010UF K		
C502,503			CC73FSL1H221J	CHIP C 220PF J		
C504			CK73FB1H103K	CHIP C 0.010UF K		

L : Scandinavia

K : USA

P : Canada

R : Mexico

Y : PX(Far East, Hawaii)

T : Europe

E : Europe

G : Germany

Y : AAFES(Europe)

X : Australia

M : Other Areas

Δ indicates safety critical components.

* New Parts
 Parts without **Parts No.** are not supplied.
 Les articles non mentionnés dans le **Parts No.** ne sont pas fournis.
 Teile ohne **Parts No.** werden nicht geliefert.

5

Ref. No	Add-ress	New Parts	Parts No.	Description	Desti-nation	Re-marks
CN1 ,2		*	E40-9966-05	FLAT CABLE CONNECTOR		
CN3			E40-8147-05	FLAT CABLE CONNECTOR		
CN4			E40-8055-05	FLAT CABLE CONNECTOR		
CN5			E40-8054-05	FLAT CABLE CONNECTOR		
CN11			E40-4293-05	FLAT CABLE CONNECTOR		
J1			E63-0120-05	PHONO JACK		
J11			E11-0188-05	MINIATURE PHONE JACK(2P)		
L1			L40-2291-31	SMALL FIXED INDUCTOR		
L2 ,3			L79-1216-05	LINE FILTER		
X1			L77-2205-05	CRYSTAL RESONATOR		
X2			L78-0277-05	RESONATOR (12.000M)		
X3			L78-0615-05	RESONATOR (12.5MHZ)		
R1 ,2			RK73FB2A102J	CHIP R 1.0K	J	1/10W
R3 ,4			RK73FB2A224J	CHIP R 220K	J	1/10W
R5 ,6			RK73FB2A104J	CHIP R 100K	J	1/10W
R7 ,8			RK73FB2A221J	CHIP R 220	J	1/10W
R11 ,12			RK73FB2A272J	CHIP R 2.7K	J	1/10W
R13 ,14			RK73FB2A102J	CHIP R 1.0K	J	1/10W
R17 ,18			RK73FB2A471J	CHIP R 470	J	1/10W
R21 ,22			RK73FB2A103J	CHIP R 10K	J	1/10W
R23 ,24			RK73FB2A563J	CHIP R 56K	J	1/10W
R25 ,26			RK73FB2A223J	CHIP R 22K	J	1/10W
R27 ,28			RK73FB2A153J	CHIP R 15K	J	1/10W
R29 ,30			RK73FB2A104J	CHIP R 100K	J	1/10W
R31 ,32			RK73FB2A222J	CHIP R 2.2K	J	1/10W
R33 ,34			RK73FB2A102J	CHIP R 1.0K	J	1/10W
R101			RK73FB2A101J	CHIP R 100	J	1/10W
R102			RK73FB2A470J	CHIP R 47	J	1/10W
R104			RK73FB2A151J	CHIP R 150	J	1/10W
R105,106			RK73FB2A103J	CHIP R 10K	J	1/10W
R107			RK73FB2A202J	CHIP R 2.0K	J	1/10W
R108			RK73FB2A103J	CHIP R 10K	J	1/10W
R109			RK73FB2A331J	CHIP R 330	J	1/10W
R110			RK73FB2A122J	CHIP R 1.2K	J	1/10W
R111,112			RK73FB2A223J	CHIP R 22K	J	1/10W
R113,114			RK73FB2A122J	CHIP R 1.2K	J	1/10W
R115			RK73FB2A101J	CHIP R 100	J	1/10W
R116			RK73FB2A100J	CHIP R 10	J	1/10W
R117			RK73FB2A331J	CHIP R 330	J	1/10W
R118			RK73FB2A561J	CHIP R 560	J	1/10W
R119			RK73FB2A102J	CHIP R 1.0K	J	1/10W
R120			RK73FB2A105J	CHIP R 1.0M	J	1/10W
R121			RK73FB2A100J	CHIP R 10	J	1/10W
R122			RK73FB2A181J	CHIP R 180	J	1/10W
R123			RK73FB2A820J	CHIP R 82	J	1/10W
R124			RK73FB2A101J	CHIP R 100	J	1/10W
R125			RK73FB2A221J	CHIP R 220	J	1/10W
R126			RK73FB2A100J	CHIP R 10	J	1/10W
R127			RD14NB2E470J	RD 47	J	1/4W
R128			R92-1840-05	CHIP R 1.62K	F	1/10W
R129			R92-1839-05	CHIP R 1.5K	F	1/10W
R130			RS14KB3A332J	FL-PROOF RS 3.3K	J	1W
R131,132			RK73FB2A472J	CHIP R 4.7K	J	1/10W
R133,134			RK73FB2A181J	CHIP R 180	J	1/10W

L : Scandinavia K : USA P : Canada R : Mexico
 Y : FX(Far East, Hawaii) T : Europe E : Europe G : Germany
 Y : AAFES(Europe) X : Australia M : Other Areas

⚠ indicates safety critical components.

* New Parts
 Parts without **Parts No.** are not supplied.
 Les articles non mentionnés dans le **Parts No.** ne sont pas fournis.
 Teile ohne **Parts No.** werden nicht geliefert.

6

Ref. No	Add-ress	New Parts	Parts No.	Description	Desti-nation	Re-marks
R135			R92-1840-05	CHIP R 1.62K	F	1/10W
R136			R92-1839-05	CHIP R 1.5K	F	1/10W
R137			RK73FB2A102J	CHIP R 1.0K	J	1/10W
R138			RK73FB2A103J	CHIP R 10K	J	1/10W
R139			RK73FB2A221J	CHIP R 220	J	1/10W
R201-203			RK73FB2A104J	CHIP R 100K	J	1/10W
R204,205			RK73FB2A101J	CHIP R 100	J	1/10W
R206			RK73FB2A104J	CHIP R 100K	J	1/10W
R207			RK73FB2A302J	CHIP R 3.0K	J	1/10W
R208			RK73FB2A101J	CHIP R 100	J	1/10W
R209-212			RK73FB2A104J	CHIP R 100K	J	1/10W
R213			RK73FB2A101J	CHIP R 100	J	1/10W
R214-216			RK73FB2A104J	CHIP R 100K	J	1/10W
R217			RK73FB2A182J	CHIP R 1.8K	J	1/10W
R218			RK73FB2A272J	CHIP R 2.7K	J	1/10W
R219			RK73FB2A561J	CHIP R 560	J	1/10W
R220			RK73FB2A102J	CHIP R 1.0K	J	1/10W
R221			RK73FB2A182J	CHIP R 1.8K	J	1/10W
R222			RK73FB2A272J	CHIP R 2.7K	J	1/10W
R223,224			RK73FB2A104J	CHIP R 100K	J	1/10W
R225			RK73FB2A103J	CHIP R 10K	J	1/10W
R226-228			RK73FB2A104J	CHIP R 100K	J	1/10W
R230			RK73FB2A103J	CHIP R 10K	J	1/10W
R231,232			RK73FB2A104J	CHIP R 100K	J	1/10W
R233			RK73FB2A182J	CHIP R 1.8K	J	1/10W
R234			RK73FB2A272J	CHIP R 2.7K	J	1/10W
R235,236			RK73FB2A101J	CHIP R 100	J	1/10W
R237			RK73FB2A183J	CHIP R 18K	J	1/10W
R238			RK73FB2A273J	CHIP R 27K	J	1/10W
R239-242			RK73FB2A101J	CHIP R 100	J	1/10W
R243			RK73FB2A104J	CHIP R 100K	J	1/10W
R244			RK73FB2A472J	CHIP R 4.7K	J	1/10W
R245			RK73FB2A104J	CHIP R 100K	J	1/10W
R246			RK73FB2A472J	CHIP R 4.7K	J	1/10W
R247			RK73FB2A101J	CHIP R 100	J	1/10W
R248-264			RK73FB2A104J	CHIP R 100K	J	1/10W
R265			RK73FB2A473J	CHIP R 47K	J	1/10W
R266,267			RK73FB2A104J	CHIP R 100K	J	1/10W
R270			RK73FB2A105J	CHIP R 1.0M	J	1/10W
R271-275			RK73FB2A104J	CHIP R 100K	J	1/10W
R276			RK73FB2A153J	CHIP R 15K	J	1/10W
R277			RK73FB2A123J	CHIP R 12K	J	1/10W
R278			RK73FB2A103J	CHIP R 10K	J	1/10W
R279			RK73FB2A331J	CHIP R 330	J	1/10W
R280,281			RK73FB2A104J	CHIP R 100K	J	1/10W
R282			RK73FB2A331J	CHIP R 330	J	1/10W
R283,284			RK73FB2A104J	CHIP R 100K	J	1/10W
R285			RK73FB2A473J	CHIP R 47K	J	1/10W
R286			RK73FB2A104J	CHIP R 100K	J	1/10W
R287			RK73FB2A472J	CHIP R 4.7K	J	1/10W
R288			RK73FB2A473J	CHIP R 47K	J	1/10W
R289			RK73FB2A101J	CHIP R 100	J	1/10W
R290			RK73FB2A471J	CHIP R 470	J	1/10W
R291			RK73FB2A104J	CHIP R 100K	J	1/10W
R292			RK73FB2A102J	CHIP R 1.0K	J	1/10W
R293,294			RK73FB2A103J	CHIP R 10K	J	1/10W

L : Scandinavia K : USA P : Canada R : Mexico
 Y : FX(Far East, Hawaii) T : Europe E : Europe G : Germany
 Y : AAFES(Europe) X : Australia M : Other Areas

⚠ indicates safety critical components.

PARTS LIST

DM-S500

* New Parts
Parts without **Parts No.** are not supplied.
Les articles non mentionnés dans le **Parts No.** ne sont pas fournis.
Teile ohne **Parts No.** werden nicht geliefert.

7

Ref. No	Add-ress	New Parts	Parts No.	Description	Desti-nation	Re-marks
R295			RK73FB2A473J	CHIP R 47K J 1/10W		
R301			RK73FB2A333J	CHIP R 33K J 1/10W		
R302,303			RK73FB2A562J	CHIP R 5.6K J 1/10W		
R304			RK73FB2A243J	CHIP R 24K J 1/10W		
R305			RK73FB2A151J	CHIP R 150 J 1/10W		
R306			RK73FB2A104J	CHIP R 100K J 1/10W		
R307-309			RK73FB2A221J	CHIP R 220 J 1/10W		
R310,311			RK73FB2A102J	CHIP R 1.0K J 1/10W		
R312			RK73FB2A473J	CHIP R 47K J 1/10W		
R313-315			RK73FB2A101J	CHIP R 100 J 1/10W		
D2			UDZ3.9B	ZENER DIODE		
D13 ,14			UDZ16B	ZENER DIODE		
D15			UDZ6.2B	ZENER DIODE		
D16			MA111	DIODE		
D17			UDZ5.6B	ZENER DIODE		
D18			UDZ8.2B	ZENER DIODE		
D20 -22			MA111	DIODE		
D24 -30			MA111	DIODE		
D33			MA111	DIODE		
D501,502			MA111	DIODE		
IC1			NJM2115M	ANALOGUE IC		
IC2			LM1972M	ANALOGUE IC		
IC3			NJM062M	ANALOGUE IC		
IC4			AK4520-VF	MOS-IC		
IC5			NJM2100M	IC(OP AMPLIFIER)		
IC6			TC74HC00AF	IC(2INPUT NAND GATE)		
IC7			TC7SU04F	MOS-IC		
IC8			HD74HC74FPEL	MOS-IC		
IC9 ,10			LM431AIZ	ANALOGUE IC		
IC11			LC8904Q	MOS-IC		
IC12			KAN03	CUSTOM IC		
IC13			SM5844AF	MOS-IC		
IC14			PST993D-T	ANALOGUE IC		
IC15			BU4094BCF	MOS-IC		
IC16			LC89170M	MOS-IC		
IC17		*	UPD784035GC806	MI-COM IC		
IC18			HD74HC373FPEL	MOS-IC		
IC19			HM62256BLFP-8T	MEMORY IC		
IC20		*	UPD784215GF506	MI-COM IC		
IC21			HM62256BLFP-8T	MEMORY IC		
IC22			HD74HC373FPEL	MOS-IC		
IC23			TA8409S	MOS-IC		
IC24			TC74HCT7007AF	IC(HEX BUFFER)		
IC25			HD74HCT126FPEL	MOS-IC		
IC26			TC74HCT7007AF	IC(HEX BUFFER)		
IC27			TC74VHC125F	MOS-IC		
Q1 ,2			2SD1450(S,T)	TRANSISTOR		
Q3 ,4			2SA1586(Y,GR)	TRANSISTOR		
Q3 ,4			2SA1611(M5,M6)	TRANSISTOR		
Q5			DTC124EUA	DIGITAL TRANSISTOR		
Q5			UN5212	DIGITAL TRANSISTOR		
Q6			2SD2012	TRANSISTOR		
Q6			2SD2061	TRANSISTOR		
Q9			2SC2458(Y,GR)	TRANSISTOR		
Q9			2SC3311A(Q,R)	TRANSISTOR		
Q10 ,11			2SA954(L,K)	TRANSISTOR		

L : Scandinavia K : USA P : Canada R : Mexico
Y : PX(Far East, Hawaii) T : Europe E : Europe G : Germany
Y : AAFES(Europe) X : Australia M : Other Areas

△ indicates safety critical components.

* New Parts
Parts without **Parts No.** are not supplied.
Les articles non mentionnés dans le **Parts No.** ne sont pas fournis.
Teile ohne **Parts No.** werden nicht geliefert.

8

Ref. No	Add-ress	New Parts	Parts No.	Description	Desti-nation	Re-marks
Q12			DTC124EUA	DIGITAL TRANSISTOR		
Q12			UN5212	DIGITAL TRANSISTOR		
Q13			2SC2003(L,K)	TRANSISTOR		
Q23			2SC4116(Y,GR)	TRANSISTOR		
Q23			2SC4177(L5,L6)	TRANSISTOR		
Q24			2SA1586(Y,GR)	TRANSISTOR		
Q24			2SA1611(M5,M6)	TRANSISTOR		
Q25			2SC2458(Y,GR)	TRANSISTOR		
Q25			2SC3311A(Q,R)	TRANSISTOR		
Q29			DTC143TU	DIGITAL TRANSISTOR		
Q29			UN5216	DIGITAL TRANSISTOR		
Q30			DTA124EUA	DIGITAL TRANSISTOR		
Q30			UN5112	DIGITAL TRANSISTOR		
Q33			DTC124EUA	DIGITAL TRANSISTOR		
Q33			UN5212	DIGITAL TRANSISTOR		
Q34			2SC2458(Y,GR)	TRANSISTOR		
Q34			2SC3311A(Q,R)	TRANSISTOR		
Q35			2SA1048(Y,GR)	TRANSISTOR		
Q35			2SA1309A(Q,R)	TRANSISTOR		
Q36			DTC124EUA	DIGITAL TRANSISTOR		
Q36			UN5212	DIGITAL TRANSISTOR		
A1 ,2			W02-1181-05	OPTIC RECEIVING MODULE		
MECHANISM PCB (X29-2580-00)						
CN1			E40-3260-05	PIN ASSY		
CN2			E40-3261-05	PIN ASSY		
CN3			E40-8076-05	FLAT CABLE CONNECTOR		
S1			S64-0028-05	LEVER SWITCH		
S2			S68-0074-05	PUSH SWITCH		
PH1			T95-0140-05	OPTO ISOLATOR		
MECHANISM CONTROL (X33-1100-00)						
C21 ,22			CC73FCH1H020C	CHIP C 2.0PF C		
C101			C92-0628-05	CHIP-TAN 10UF 10WV		
C102			CK73FB1E104K	CHIP C 0.10UF K		
C103,104			C92-0628-05	CHIP-TAN 10UF 10WV		
C105			CK73FB1H103K	CHIP C 0.010UF K		
C106			CC73FCH1H102J	CHIP C 1000PF J		
C107,108			CK73FF1E104Z	CHIP C 0.10UF Z		
C109			CK73FB1H223K	CHIP C 0.022UF K		
C110			CK73FB1E104K	CHIP C 0.10UF K		
C111			CK73FB1H683K	CHIP C 0.068UF K		
C112			CK73FB1H472K	CHIP C 4700PF K		
C113			CK73FF1C105Z	CHIP C 1.0UF Z		
C115			CK73FB1C224K	CHIP C 0.22UF K		
C116			CK73FB1H223K	CHIP C 0.022UF K		
C117,118			CK73FB1E104K	CHIP C 0.10UF K		
C119			C92-0628-05	CHIP-TAN 10UF 10WV		
C121			C92-0048-05	ELECTRO 100UF 6.3WV		
C122			CK73FB1H103K	CHIP C 0.010UF K		
C123			CK73FF1E104Z	CHIP C 0.10UF Z		
C127			CK73FF1E104Z	CHIP C 0.10UF Z		
C128			CK73FB1H103K	CHIP C 0.010UF K		
C129			CK73FB1C474K	CHIP C 0.47UF K		

L : Scandinavia K : USA P : Canada R : Mexico
Y : PX(Far East, Hawaii) T : Europe E : Europe G : Germany
Y : AAFES(Europe) X : Australia M : Other Areas

△ indicates safety critical components.

* New Parts
Parts without **Parts No.** are not supplied.
Les articles non mentionnés dans le **Parts No.** ne sont pas fournis.
Teile ohne **Parts No.** werden nicht geliefert.



Ref. No	Add-ress	New Parts	Parts No.	Description	Desti-nation	Re-marks
C130			CC73FSL1H101J	CHIP C	100PF	J
C131			CK73FB1H153K	CHIP C	0.015UF	K
C132			CK73FB1C474K	CHIP C	0.47UF	K
C133			CK73FB1H472K	CHIP C	4700PF	K
C134,135			CK73FF1E104Z	CHIP C	0.10UF	Z
C136			C92-0048-05	ELECTRO	100UF	6.3WV
C141			CK73FF1E104Z	CHIP C	0.10UF	Z
C142-144			CC73FSL1H101J	CHIP C	100PF	J
C146			CK73FF1E104Z	CHIP C	0.10UF	Z
C151			C92-0048-05	ELECTRO	100UF	6.3WV
C152			CK73FF1E104Z	CHIP C	0.10UF	Z
C153			CK73FB1H103K	CHIP C	0.010UF	K
C156			CK73FF1E104Z	CHIP C	0.10UF	Z
C158			CK73FB1H682K	CHIP C	6800PF	K
C160,161			C92-0167-05	CHIP-ELE	10UF	10WV
C163,164			CK73FB1H103K	CHIP C	0.010UF	K
C167,168			CK73FF1E104Z	CHIP C	0.10UF	Z
C169			C92-0628-05	CHIP-TAN	10UF	10WV
C171			CK73FF1E104Z	CHIP C	0.10UF	Z
C181			C92-0048-05	ELECTRO	100UF	6.3WV
C182,183			CK73FF1E104Z	CHIP C	0.10UF	Z
C184			C92-0149-05	CHIP-ELE	22UF	8WV
C185			C93-0031-05	CHIP-C	1000P	500V
C187			C92-0048-05	ELECTRO	100UF	6.3WV
C188			CK73FB1H103K	CHIP C	0.010UF	K
C189			CK73FB1H333K	CHIP C	0.033UF	K
C190			C92-0048-05	ELECTRO	100UF	6.3WV
C191			CK73FF1E104Z	CHIP C	0.10UF	Z
C195			CK73FF1C105Z	CHIP C	1.0UF	Z
C196,197			CK73FF1E104Z	CHIP C	0.10UF	Z
C200			C93-0032-05	CHIP C	10UF	10WV
CN101			E40-8074-05	FLAT CABLE CONNECTOR		
CN102			E40-8075-05	FLAT CABLE CONNECTOR		
CN103			E40-8077-05	FLAT CABLE CONNECTOR		
CN104			E40-8078-05	PIN ASSY		
CN105			E40-8076-05	FLAT CABLE CONNECTOR		
L1 ,2			L33-0545-05	CHOKE COIL		
L3 ,4			L33-0369-05	CHOKE COIL		
L5 -11			L79-1216-05	LINE FILTER		
R103			RK73FB2A102J	CHIP R	1.0K	J 1/10W
R104			RK73FB2A103J	CHIP R	10K	J 1/10W
R105			RK73FB2A472J	CHIP R	4.7K	J 1/10W
R106			RK73FB2A335J	CHIP R	3.3M	J 1/10W
R107			RK73FB2A474J	CHIP R	470K	J 1/10W
R108,109			RK73FB2A102J	CHIP R	1.0K	J 1/10W
R110			RK73FB2A103J	CHIP R	10K	J 1/10W
R112			RK73FB2A473J	CHIP R	47K	J 1/10W
R113			RK73FB2A102J	CHIP R	1.0K	J 1/10W
R115			RK73FB2A102J	CHIP R	1.0K	J 1/10W
R117			RK73FB2A474J	CHIP R	470K	J 1/10W
R120			RK73FB2A101J	CHIP R	100	J 1/10W
R121			RK73FB2A104J	CHIP R	100K	J 1/10W
R123			RK73FB2A221J	CHIP R	220	J 1/10W
R124,125			RK73FB2A101J	CHIP R	100	J 1/10W
R127			RK73FB2A101J	CHIP R	100	J 1/10W

L : Scandinavia K : USA P : Canada R : Mexico
Y : FX(Far East, Hawaii) T : Europe E : Europe G : Germany
Y : AAFES(Europe) X : Australia M : Other Areas

⚠ indicates safety critical components.

* New Parts
Parts without **Parts No.** are not supplied.
Les articles non mentionnés dans le **Parts No.** ne sont pas fournis.
Teile ohne **Parts No.** werden nicht geliefert.



Ref. No	Add-ress	New Parts	Parts No.	Description	Desti-nation	Re-marks
R131			RK73FB2A103J	CHIP R	10K	J 1/10W
R132			RK73FB2A104J	CHIP R	100K	J 1/10W
R133			RK73FB2A684J	CHIP R	680K	J 1/10W
R134			RK73FB2A102J	CHIP R	1.0K	J 1/10W
R135			RK73FB2A332J	CHIP R	3.3K	J 1/10W
R136			RK73FB2A102J	CHIP R	1.0K	J 1/10W
R137			RK73FB2A101J	CHIP R	100	J 1/10W
R140			RK73FB2A151J	CHIP R	150	J 1/10W
R141			RK73FB2A561J	CHIP R	560	J 1/10W
R142,143			RK73FB2A103J	CHIP R	10K	J 1/10W
R144			RK73FB2A101J	CHIP R	100	J 1/10W
R146-148			RK73FB2A101J	CHIP R	100	J 1/10W
R150			RK73FB2A221J	CHIP R	220	J 1/10W
R158,159			RK73FB2A104J	CHIP R	100K	J 1/10W
R161-163			RK73FB2A222J	CHIP R	2.2K	J 1/10W
R164			RK73FB2A681J	CHIP R	680	J 1/10W
R165			RK73FB2A104J	CHIP R	100K	J 1/10W
R166			R92-1854-05	RN	2.2	K 1/2W
R167			RK73FB2A472J	CHIP R	4.7K	J 1/10W
R169			R92-1853-05	CHIP-RN	1	1/4W
R170,171			RK73FB2A103J	CHIP R	10K	J 1/10W
R173			RK73FB2A105J	CHIP R	1.0M	J 1/10W
R175			RK73FB2A332J	CHIP R	3.3K	J 1/10W
R177			RK73FB2A332J	CHIP R	3.3K	J 1/10W
R179			RK73FB2A473J	CHIP R	47K	J 1/10W
R180,181			RK73FB2A103J	CHIP R	10K	J 1/10W
R182,183			RK73FB2A473J	CHIP R	47K	J 1/10W
R184,185			RK73FB2A103J	CHIP R	10K	J 1/10W
R188-190			RK73FB2A103J	CHIP R	10K	J 1/10W
W1 -4			R92-0670-05	CHIP R	0 OHM	
W101			R92-0670-05	CHIP R	0 OHM	
W108			R92-0679-05	CHIP R	0 OHM	
W109			R92-0670-05	CHIP R	0 OHM	
W111			R92-0670-05	CHIP R	0 OHM	
W114			R92-0670-05	CHIP R	0 OHM	
W116			R92-0670-05	CHIP R	0 OHM	
W178			R92-0670-05	CHIP R	0 OHM	
W186,187			R92-0679-05	CHIP R	0 OHM	
W195,196			R92-0670-05	CHIP R	0 OHM	
W198-201			R92-0670-05	CHIP R	0 OHM	
D1 ,2			F1J6TP	DIODE		
D101			MA111	DIODE		
IC1			CXA2523AR	ANALOGUE IC		
IC2			CXD2652AR	MOS-IC		
IC3			TC7S08FU	MOS-IC		
IC4			TC7WU04FU	MOS-IC		
IC5			TC74ACT540FS	MOS-IC		
IC6			X24C01AS-2.7	MEMORY IC		
IC7			HM51W4400BTT-7	MEMORY IC		
IC8			BH6511FS	ANALOGUE IC		
IC10			L88MS33T	ANALOGUE IC		
Q1			FMW1	TRANSISTOR		
Q2 ,3			DTA144EUA	DIGITAL TRANSISTOR		
Q4 ,5			DTC114YUA	DIGITAL TRANSISTOR		
Q6			2SA1576A(R,S)	TRANSISTOR		
Q7			2SB798-DL	TRANSISTOR		

L : Scandinavia K : USA P : Canada R : Mexico
Y : FX(Far East, Hawaii) T : Europe E : Europe G : Germany
Y : AAFES(Europe) X : Australia M : Other Areas

⚠ indicates safety critical components.

PARTS LIST

DM-S500

